

ENVIRONMENTAL ASSESSMENT

*Environmental Assessment  
Appendices*

*Fort Norfolk Pier Rehabilitation and Expansion Project  
USACE, Norfolk District, Fort Norfolk, Virginia*

---

# APPENDIX G

---

## Essential Fish Habitat Assessment



Reply to  
Attention of

**DEPARTMENT OF THE ARMY**  
**US ARMY CORPS OF ENGINEERS**  
**NORFOLK DISTRICT**  
**FORT NORFOLK**  
**803 FRONT STREET**  
**NORFOLK VA 23510-1011**

January 6, 2022

David O'Brien  
Habitat and Ecosystem Services Division  
National Marine Fisheries Service – Virginia Field Office  
1370 Greate Road  
Gloucester Point, Virginia 23062

Dear Mr. O'Brien:

I am requesting an abbreviated Essential Fish Habitat (EFH) consultation for the NAO Pier Rehabilitation and Improvements Project, located at Fort Norfolk, Norfolk, Virginia. This project includes improvements to the existing NAO pier to allow for the safe mooring of three 65 foot vessels and to protect the mooring location from wave action and severe storm events. A full description of the work and drawings are included in this package.

In accordance with the GARFO EFH Assessment Worksheet, the USACE, Norfolk District has determined that the adverse effects on EFH due to the proposed project actions are not substantial.

Should you have any questions or require further information on this submittal, please contact Shannon Reinheimer of my staff at [shannon.j.reinheimer@usace.army.mil](mailto:shannon.j.reinheimer@usace.army.mil) or 757-201-7074. Thank you for your assistance.

Sincerely,

Digitally signed by DOBBINS-  
NOBLE.LESLEY.CAROLE.10474168  
48  
Date: 2022.01.06 12:09:06 -05'00'

**Lesley Dobbins-Noble**  
Chief, Operations Branch

Enclosures:  
GARFO EFH Worksheet  
Appendix A: Project Description and Purpose  
Drawings

**EFH Assessment Worksheet rev. August 2021**  
Please read and follow all of the directions provided when filling out this form.

**1. General Project Information**

Date Submitted:

Project/Application Number:

Project Name:

Project Sponsor/Applicant:

Federal Action Agency (or state agency if the federal agency has provided written notice delegating the authority<sup>1</sup>):

Fast-41:      Yes                       No

Action Agency Contact Name:

Contact Phone:       Contact Email:

Address, City/Town, State:

**2. Project Description**

<sup>2</sup>Latitude:       Longitude:

Body of Water (e.g., HUC 6 name):

Project Purpose:

Project Description:

Anticipated Duration of In-Water Work including planned Start/End Dates and any seasonal restrictions proposed to be included in the schedule:

<sup>1</sup> A federal agency may designate a non-Federal representative to conduct an EFH consultation by giving written notice of such designation to NMFS. If a non-federal representative is used, the Federal action agency remains ultimately responsible for compliance with sections 305(b)(2) and 305(b)(4)(B) of the Magnuson-Stevens Act. <sup>2</sup> Provide the decimal, or the degrees, minutes, seconds values for latitude and longitude using the World Geodetic System 1984 (WGS84) and negative degree values where applicable.

### 3. Site Description

EFH includes the biological, chemical, and physical components of the habitat. This includes the substrate and associated biological resources (e.g., benthic organisms, submerged aquatic vegetation, shellfish beds, salt marsh wetlands), the water column, and prey species.

- Is the project in designated EFH<sup>3</sup>?  Yes  No
- Is the project in designated HAPC?  Yes  No
- Does the project contain any Special Aquatic Sites<sup>4</sup>?  Yes  No
- Is this coordination under FWCA only?  Yes  No

Total area of impact to EFH (indicate sq ft or acres):

Total area of impact to HAPC (indicate sq ft or acres):

Current range of water depths at MLW  Salinity range (PPT):  Water temperature range (°F):

<sup>3</sup>Use the tables in Sections 5 and 6 to list species within designated EFH or the type of designated HAPC present. See the worksheet instructions to find out where EFH and HAPC designations can be found. <sup>4</sup>Special aquatic sites (SAS) are geographic areas, large or small, possessing special ecological characteristics of productivity, habitat, wildlife protection, or other important easily disrupted ecological values. These areas are generally recognized as significantly influencing or positively contributing to the general overall environmental health or vitality of the entire ecosystem of a region. They include sanctuaries and refuges, wetlands, mudflats, vegetated shallows, coral reefs, and riffle and pool complexes (40 CFR Subpart E). If the project area contains SAS (i.e. sanctuaries and refuges, wetlands, mudflats, vegetated shallows/SAV, coral reefs, and/or riffle and pool complexes, describe the SAS, species or habitat present, and area of impact.

### 4. Habitat Types

In the table below, select the location and type(s) for each habitat your project overlaps. For each habitat type selected, indicate the total area of expected impacts, then what portion of the total is expected to be temporary (less than 12 months) and what portion is expected to be permanent (habitat conversion), and if the portion of temporary impacts will be actively restored to pre- construction conditions by the project proponent or not. A project may overlap with multiple habitat types.

Habitat Location	Habitat Type	Total impacts (lf/ft <sup>2</sup> /ft <sup>3</sup> )	Temporary impacts (lf/ft <sup>2</sup> /ft <sup>3</sup> )	Permanent impacts (lf/ft <sup>2</sup> /ft <sup>3</sup> )	Restored to pre-existing conditions?*
Marine	Substrate (sand/shell)	29300 ft <sup>3</sup>	N/A	29300 ft <sup>3</sup>	No
Select one	Select One				Select one
Select one	Select One				Select one
Select one	Select One				Select one
Select one	Select One				Select one
Select one	Select One				Select one
Select one	Select One				Select one
Select one	Select One				Select one

\*Restored to pre-existing conditions means that as part of the project, the temporary impacts will be actively restored, such as restoring the project elevations to pre-existing conditions and replanting. It does not include natural restoration or compensatory mitigation.

**Submerged Aquatic Vegetation (SAV) Present?:**

Yes:

No:

If the project area contains SAV, or has historically contained SAV, list SAV species and provide survey results including plans showing its location, years present and densities if available. Refer to Section 12 below to determine if local SAV mapping resources are available for your project area.

**Sediment Characteristics:**

The level of detail required is dependent on your project – e.g., a grain size analysis may be necessary for dredging. In addition, if the project area contains rocky/hard bottom habitat <sup>6</sup>(pebble, cobble, boulder, bedrock outcrop/ledge) identified as Rocky (coral/rock), Substrate (cobble/gravel), or Substrate (rock) above, describe the composition of the habitat using the following table.

Substrate Type* (grain size)	Present at Site? (Y/N)	Approximate Percentage of Total Substrate on Site
Silt/Mud (<0.063mm)	Yes	28.6%
Sand (0.063-2mm)	Yes	71.4%
Rocky: Pebble/Gravel /Cobble(2-256mm)**	No	
Rocky: Boulder (256-4096mm)**	No	
Rocky: Coral	No	
Bedrock**	No	

<sup>6</sup>The type(s) of rocky habitat will help you determine if the area is cod HAPC.

\* Grain sizes are based on Wentworth grain size classification scale for granules, pebbles, cobbles, and boulders.

\*\* Sediment samples with a content of 10% or more of pebble-gravel-cobble and/or boulder in the top layer (6-12 inches) should be delineated and material with epifauna/macroalgae should be differentiated from bare pebble-gravel-cobble and boulder.

If no grain size analysis has been conducted, please provide a general description of the composition of the sediment. If available please attach images of the substrate.

**Diadromous Fish (migratory or spawning habitat- identify species under Section 10 below):**

Yes:

No:

## 5. EFH and HAPC Designations

Within the Greater Atlantic Region, EFH has been designated by the New England, Mid-Atlantic, and South Atlantic Fisheries Management Councils and NOAA Fisheries. Use the [EFH mapper](#) to determine if EFH may be present in the project area and enter all species and life stages that have designated EFH. Optionally, you may review the EFH text descriptions linked to each species in the EFH mapper and use them to determine if the described habitat is present at your project site. If the habitat characteristics described in the text descriptions do not exist at your site, you may be able to exclude some species or life stages from additional consideration. For example, the water depths at your site are shallower than those described in the text description for a particular species or life stage. We recommend this for larger projects to help you determine what your impacts are.

Species Present	EFH is designated/mapped for:				What is the source of the EFH information included?
	EFH: eggs	EFH: larvae	EFH: juvenile	EFH: adults/spawning adults	
little skate	<input type="checkbox"/>	<input type="checkbox"/>	<input type="checkbox"/>	<input checked="" type="checkbox"/>	EFH Mapper d
Atlantic herring	<input type="checkbox"/>	<input type="checkbox"/>	<input checked="" type="checkbox"/>	<input checked="" type="checkbox"/>	EFH Mapper d
red hake	<input checked="" type="checkbox"/>	<input checked="" type="checkbox"/>	<input checked="" type="checkbox"/>	<input checked="" type="checkbox"/>	EFH Mapper d
winter skate	<input type="checkbox"/>	<input type="checkbox"/>	<input type="checkbox"/>	<input checked="" type="checkbox"/>	EFH Mapper d
clearnose skate	<input type="checkbox"/>	<input type="checkbox"/>	<input checked="" type="checkbox"/>	<input checked="" type="checkbox"/>	EFH Mapper d
windowpane flounder	<input type="checkbox"/>	<input type="checkbox"/>	<input checked="" type="checkbox"/>	<input type="checkbox"/>	EFH Mapper d
bluefish	<input type="checkbox"/>	<input type="checkbox"/>	<input checked="" type="checkbox"/>	<input checked="" type="checkbox"/>	EFH Mapper d
Atlantic butterfish	<input type="checkbox"/>	<input type="checkbox"/>	<input checked="" type="checkbox"/>	<input checked="" type="checkbox"/>	EFH Mapper d
summer flounder	<input type="checkbox"/>	<input checked="" type="checkbox"/>	<input checked="" type="checkbox"/>	<input checked="" type="checkbox"/>	EFH Mapper d
Black sea bass	<input type="checkbox"/>	<input type="checkbox"/>	<input checked="" type="checkbox"/>	<input checked="" type="checkbox"/>	EFH Mapper d
Select One	<input type="checkbox"/>	<input type="checkbox"/>	<input type="checkbox"/>	<input type="checkbox"/>	Select One

## 6. Habitat Areas of Particular Concern (HAPCs)

HAPCs are subsets of EFH that are important for long-term productivity of federally managed species. HAPCs merit special consideration based their ecological function (current or historic), sensitivity to human-induced degradation, stresses from development, and/or rarity of the habitat. While many HAPC designations have geographic boundaries, there are also habitat specific HAPC designations for certain species, see note below. Use the [EFH mapper](#) to identify HAPCs within your project area. Select all that apply.

<input checked="" type="checkbox"/>	Summer flounder: SAV <sup>7</sup>	<input type="checkbox"/>	Alvin & Atlantis Canyons
<input type="checkbox"/>	Sandbar shark	<input type="checkbox"/>	Baltimore Canyon
<input type="checkbox"/>	Sand Tiger Shark (Delaware Bay)	<input type="checkbox"/>	Bear Seamount
<input type="checkbox"/>	Sand Tiger Shark (Plymouth-Duxbury-Kingston Bay)	<input type="checkbox"/>	Heezen Canyon
<input type="checkbox"/>	Inshore 20m Juvenile Cod <sup>8</sup>	<input type="checkbox"/>	Hudson Canyon
<input type="checkbox"/>	Great South Channel Juvenile Cod	<input type="checkbox"/>	Hydrographer Canyon
<input type="checkbox"/>	Northern Edge Juvenile Cod	<input type="checkbox"/>	Jeffreys & Stellwagen
<input type="checkbox"/>	Lydonia Canyon	<input type="checkbox"/>	Lydonia, Gilbert & Oceanographer Canyons
<input type="checkbox"/>	Norfolk Canyon (Mid-Atlantic)	<input type="checkbox"/>	Norfolk Canyon (New England)
<input type="checkbox"/>	Oceanographer Canyon	<input type="checkbox"/>	Retriever Seamount
<input type="checkbox"/>	Veatch Canyon (Mid-Atlantic)	<input type="checkbox"/>	Toms, Middle Toms & Hendrickson Canyons
<input type="checkbox"/>	Veatch Canyon (New England)	<input type="checkbox"/>	Washington Canyon
<input type="checkbox"/>	Cashes Ledge	<input type="checkbox"/>	Wilmington Canyon
<input type="checkbox"/>	Atlantic Salmon		

<sup>7</sup> Summer flounder HAPC is defined as all native species of macroalgae, seagrasses, and freshwater and tidal macrophytes in any size bed, as well as loose aggregations, within adult and juvenile summer flounder EFH. In locations where native species have been eliminated from an area, then exotic species are included. Use local information to determine the locations of HAPC.

<sup>8</sup> The purpose of this HAPC is to recognize the importance of inshore areas to juvenile Atlantic cod. The coastal areas of the Gulf of Maine and Southern New England contain structurally complex rocky-bottom habitat that supports a wide variety of emergent epifauna and benthic invertebrates. Although this habitat type is not rare in the coastal Gulf of Maine, it provides two key ecological functions for juvenile cod: protection from predation, and readily available prey. See [EFH mapper](#) for links to text descriptions for HAPCs.

## 7. Activity Details

Select all that apply	Project Type/Category
<input type="checkbox"/>	Agriculture
<input type="checkbox"/>	Aquaculture - <u>List species here:</u>
<input type="checkbox"/>	Bank/shoreline stabilization (e.g., living shoreline, groin, breakwater, bulkhead)
<input type="checkbox"/>	Beach renourishment
<input type="checkbox"/>	Dredging/excavation
<input type="checkbox"/>	Energy development/use e.g., hydropower, oil and gas, pipeline, transmission line, tidal or wave power, wind
<input checked="" type="checkbox"/>	Fill Steel Pipe and Timber Pile placement, concrete within piles, sedimentation from wave screens
<input type="checkbox"/>	Forestry
<input type="checkbox"/>	Infrastructure/transportation (e.g., culvert construction, bridge repair, highway, port, railroad)
<input type="checkbox"/>	Intake/outfall
<input type="checkbox"/>	Military (e.g., acoustic testing, training exercises)
<input type="checkbox"/>	Mining (e.g., sand, gravel)
<input type="checkbox"/>	Overboard dredged material placement
<input checked="" type="checkbox"/>	Piers, ramps, floats, and other structures Docks, platforms, wave screens, and boat lift
<input type="checkbox"/>	Restoration or fish/wildlife enhancement (e.g., fish passage, wetlands, mitigation bank/ILF creation)
<input type="checkbox"/>	Survey (e.g., geotechnical, geophysical, habitat, fisheries)
<input type="checkbox"/>	Water quality (e.g., storm water drainage, NPDES, TMDL, wastewater, sediment remediation)
<input type="checkbox"/>	Other:



## 8. Effects Evaluation

Select all that apply	Potential Stressors Caused by the Activity
<input checked="" type="checkbox"/>	Underwater noise
<input checked="" type="checkbox"/>	Water quality/turbidity/contaminant release
<input checked="" type="checkbox"/>	Vessel traffic/barge grounding
<input type="checkbox"/>	Impingement/entrainment
<input type="checkbox"/>	Prevent fish passage/spawning
<input checked="" type="checkbox"/>	Benthic community disturbance
<input checked="" type="checkbox"/>	Impacts to prey species

Select all that apply and if temporary <sup>9</sup> or permanent		Habitat alterations caused by the activity
Temp	Perm	
<input type="checkbox"/>	<input type="checkbox"/>	Water depth change
<input type="checkbox"/>	<input type="checkbox"/>	Tidal flow change
<input type="checkbox"/>	<input checked="" type="checkbox"/>	Fill
<input type="checkbox"/>	<input type="checkbox"/>	Habitat type conversion
<input type="checkbox"/>	<input type="checkbox"/>	Other: <input type="text"/>
<input type="checkbox"/>	<input type="checkbox"/>	Other: <input type="text"/>

<sup>9</sup>Temporary in this instance means during construction. <sup>10</sup>Entrainment is the voluntary or involuntary movement of aquatic organisms from a water body into a surface diversion or through, under, or around screens and results in the loss of the organisms from the population. Impingement is the involuntary contact and entrapment of aquatic organisms on the surface of intake screens caused when the approach velocity exceeds the swimming capability of the organism.

### Details - project impacts and mitigation

Briefly describe how the project would impact each of the habitat types selected above and the amount (i.e., acreage or sf) of each habitat impacted. Include temporary and permanent impact descriptions and direct and indirect impacts. For example, dredging has a direct impact on bottom sediments and associated benthic communities. The turbidity generated can result in a temporary impact to water quality which may have an indirect effect on some species and habitats such as winter flounder eggs, SAV or rocky habitats. The level of detail that you provide should be commensurate with the magnitude of impacts associated with the proposed project. Attach supplemental information if necessary.

The proposed project will result in a temporary increase of underwater noise and water turbidity. Additionally the proposed project will result in a permanent but minimal increase in vessel traffic and permanent but minimal impacts to prey species and the benthic community. Please see the attached supplemental document for more details.

What specific measures will be used to avoid and minimize impacts, including project design, turbidity controls, acoustic controls, and time of year restrictions? If impacts cannot be avoided or minimized, why not?

The project is designed with the minimal footprint necessary to complete the project purpose, minimizing impact to the essential fish habitat. Additionally, a turbidity curtain will be used during construction. The project location is within the Elizabeth River.

Is compensatory mitigation proposed?    Yes             No

If compensatory mitigation is not proposed, why not? If yes, describe plans for compensatory mitigation (e.g. permittee responsible, mitigation bank, in-lieu fee) and how this will offset impacts to EFH and other aquatic resources. Include a proposed compensatory mitigation and monitoring plan as applicable.

There is no compensatory mitigation proposed as the impacts to the surrounding area as a result of the project are minimal.

### 9. Effects of Climate Change

Effects of climate change should be included in the EFH assessment if the effects of climate change may amplify or exacerbate the adverse effects of the proposed action on EFH. Use the [Intergovernmental Panel on Climate Change \(IPCC\) Representative Concentration Pathways \(RCP\) 8.5/high greenhouse gas emission scenario \(IPCC 2014\)](#), at a minimum, to evaluate the future effects of climate change on the proposed projections. For sea level rise effects, use the intermediate-high and extreme scenario projections as defined in [Sweet et al. \(2017\)](#). For more information on climate change effects to species and habitats relative to NMFS trust resources, see [Guidance for Integrating Climate Change Information in Greater Atlantic Region Habitat Conservation Division Consultation Processes](#).

1. Could species or habitats be adversely affected by the proposed action due to projected changes in the climate? If yes, please describe how:

No.

2. Is the expected lifespan of the action greater than 10 years? If yes, please describe project lifespan:

Installation of the project will last approximately one year. The structures will stay in place for approximately 25 years before needing rehabilitation.

3. Is climate change currently affecting vulnerable species or habitats, and would the effects of a proposed action be amplified by climate change? If yes, please describe how:

No.

4. Do the results of the assessment indicate the effects of the action on habitats and species will be amplified by climate change? If yes, please describe how:

No.

5. Can adaptive management strategies (AMS) be integrated into the action to avoid or minimize adverse effects of the proposed action as a result of climate? If yes, please describe how:

No.

## 10. Federal Agency Determination

Federal Action Agency's EFH determination (select one)	
<input type="checkbox"/>	There is no adverse effect <sup>7</sup> on EFH or EFH is not designated at the project site. EFH Consultation is not required. This is a FWCA only request.
<input checked="" type="checkbox"/>	The adverse effect <sup>7</sup> on EFH is not substantial. This means that the adverse effects are no more than minimal, temporary, or can be alleviated with minor project modifications or conservation recommendations. This is a request for an abbreviated EFH consultation.
<input type="checkbox"/>	The adverse effect <sup>7</sup> on EFH is substantial. This is a request for an expanded EFH consultation. We will provide more detailed information, including an alternatives analysis and NEPA documents, if applicable.

<sup>7</sup> An adverse effect is any impact that reduces the quality and/or quantity of EFH. Adverse effects may include direct or indirect physical, chemical, or biological alterations of the waters or substrate and loss of, or injury to, benthic organisms, prey species and their habitat, and other ecosystem components. Adverse effects to EFH may result from actions occurring within EFH or outside of EFH and may include site-specific or habitat-wide impacts, including individual, cumulative, or synergistic consequences of actions.

## 11. Fish and Wildlife Coordination Act

Under the FWCA, federal agencies are required to consult with us if actions that the authorize, fund, or undertake will result in modifications to a natural stream or body of water. Federal agencies are required to consider the effects these modifications may have on fish and wildlife resources, as well as provide for the improvement of those resources. Under this authority, we consider the effects of actions on NOAA-trust resources, such as anadromous fish, shellfish, crustaceans, or their habitats, that are not managed under a federal fisheries management plan. Some examples of other NOAA-trust resources are listed below. Some of these species, including diadromous fishes, serve as prey for a number of federally-managed species and are therefore considered a component of EFH pursuant to the MSA. We will be considering the effects of your project on these species and their habitats as part of the EFH/FWCA consultation process and may make recommendations to avoid, minimize or offset and adverse effects concurrently with our EFH conservation recommendations.

Please contact our Greater Atlantic Regional Fisheries Office, [Protected Resources Division](#) regarding potential impacts to marine mammals or species listed under the Endangered Species Act and the appropriate consultation procedures.

## Fish and Wildlife Coordination Act Resources

Species known to occur at site (list others that may apply)	Describe habitat impact type (i.e., physical, chemical, or biological disruption of spawning and/or egg development habitat, juvenile nursery and/or adult feeding or migration habitat). Please note, impacts to federally listed species of fish, sea turtles, and marine mammals must be coordinated with the GARFO Protected Resources Division.
alewife	
American eel	
American shad	
Atlantic menhaden	
blue crab	
blue mussel	
blueback herring	
Eastern oyster	
horseshoe crab	
quahog	
soft-shell clams	
striped bass	
other species:	
other species:	
other species:	

## **12. Useful Links**

[National Wetland Inventory Maps](#)

[EPA's National Estuary Program \(NEP\)](#)

[Northeast Regional Ocean Council \(NROC\) Data Portal](#)

[Mid-Atlantic Regional Council on the Ocean \(MARCO\) Data Portal](#)

### **Resources by State**

#### **Maine**

[Maine Office of GIS Data Catalog](#)

[Town shellfish information including shellfish conservation area maps](#)

[State of Maine Shellfish Sanitation and Management](#)

[Eelgrass maps](#)

[Casco Bay Estuary Partnership](#)

[Maine GIS Stream Habitat Viewer](#)

#### **New Hampshire**

[NH Statewide GIS Clearinghouse, NH GRANIT](#)

[NH Coastal Viewer](#)

[State of NH Shellfish Program](#)

#### **Massachusetts**

[MA DMF Shellfish Sanitation and Management Program](#)

[MassGIS Data \(Including Eelgrass Maps\)](#)

[MA DMF Recommended TOY Restrictions Document Massachusetts](#)

[Bays National Estuary Program](#)

[Buzzards Bay National Estuary Program](#)

[Massachusetts Division of Marine Fisheries](#)

[Massachusetts Office of Coastal Zone Management](#)

#### **Rhode Island**

[RI Shellfish and Aquaculture](#)

[RI Shellfish Management Plan](#)

[RI Eelgrass Maps](#)

[Narragansett Bay Estuary Program](#)

[Rhode Island Division of Marine Fisheries](#)

[Rhode Island Coastal Resources Management Council](#)

**Connecticut**

[CT Bureau of Aquaculture](#)

[Natural Shellfish Beds in CT](#)

[Eelgrass Maps](#)

[Long Island Sound Study](#)

[CT GIS Resources](#)

[CT DEEP Office of Long Island Sound Programs and Fisheries](#)

[CT River Watershed Council](#)

**New York**

[Eelgrass Report](#)

[Peconic Estuary Program](#)

[NY/NJ Harbor Estuary Program](#)

[New York GIS Clearinghouse](#)

**New Jersey**

[Submerged Aquatic Vegetation Mapping](#)

[Barnegat Bay Partnership](#)

[NJ GeoWeb](#)

[NJ DEP Shellfish Maps](#)

**Pennsylvania**

[Delaware River Management Plan](#)

[PA DEP Coastal Resources Management Program](#)

[PA DEP GIS Mapping Tools](#)

**Delaware**

[Partnership for the Delaware Estuary](#)

[Center for Delaware Inland Bays](#)

[Delaware FirstMap](#)

**Maryland**

[Submerged Aquatic Vegetation Mapping](#)

[MERLIN \(Maryland's Environmental Resources and Land Information Network\)](#)

[Maryland Coastal Atlas](#)

[Maryland Coastal Bays Program](#)

**Virginia**

[VMRC Habitat Management Division](#)

[Submerged Aquatic Vegetation mapping](#)

# NAO Pier Rehabilitation

## EFH ASSESSMENT SUPPLEMENT

*EFH Section 8: Describe how the project would impact each of the habitat types selected above. Include temporary and permanent impact descriptions and direct and indirect impacts.*

### Noise

Noise and vibration sources from the proposed project are likely to occur in the project footprint and action area as a result of the driving of piles and support vessel traffic through the project area. Minimal temporary impacts from pile driving are expected. All 64 piles will be advanced using a vibratory hammer and a soft start. Eight of the 18-inch-diameter steel pipe piles will be driven with an impact hammer for the final approximately 10 feet of depth to confirm the axial capacities have been reached. 4 of the piles are timber piles. The species that may be behaviorally affected are Sturgeon, Salmon, and Cetacean. Additionally, Sturgeon and Salmon may be physiologically affected.

### Vessel Traffic

Vessel traffic impacts from the work area will be short in duration, causing minor and temporary effects. The Proposed Action is projected to be short in duration, with a period of performance of approximately 365 days. During construction, the only vessel present will be a work barge, which will be a temporary disturbance. Following construction, three USACE vessels will habitually moor at this site, causing a permanent disturbance. Any present aquatic life may be disturbed by this vessel traffic; however, the channel is wide at this site and there is sufficient room for the wildlife to evade the vessel traffic.

### Water Quality

The Proposed Action would result in temporary impacts to water quality at the pile driving sites. Impacts to water quality would be minor, temporary and localized to the area around the pile placement area. The turbidity generated can result in a temporary impact to water quality which may have an indirect effect on some species and habitats such as winter flounder eggs, SAV or rocky habitats. Localized turbidity would dissipate once pile driving has ceased. The surrounding sediment material is comprised of greater than 70% sand and below 30% soft clay, which is expected to settle quickly. Due to the area of impact and relatively short duration of the pile driving activity, the Proposed Action would not significantly impact water quality in the area of potential impacts. Additionally, the surrounding waters offer sufficient area to escape from any temporary disturbances in water quality that may occur. The soft start method will warn aquatic life to depart from the area prior to pile driving.

### Benthic Community Disturbance

The NAO Pier project would result in localized, temporary impacts to existing resources in the pile driving sites. This may occur through negative impacts on water quality, including decreases in Dissolved Oxygen, increased turbidity, and increased Total Suspended Solids in the water column. Potential impacts to fisheries management will include temporary disturbance to feeding and localized movement patterns for species that may be within the project area. Mobile species would move out of the area and return once construction has been completed. There would be a temporary loss of prey for benthic species, but this would soon repopulate once construction is completed.

## NAO Pier Rehabilitation

Additionally, resources could become injured during the pile placement. However, these impacts would be minor and would not be anticipated to impact fishery populations.

VMRC mapping indicates the presence of oyster habitat on the site that is owned by USACE Norfolk District. Norfolk District has a sanctuary oyster reef, biogenic reef structures, and various other oyster structures (oyster bergs and oyster castles) adjacent to the pier on either side of the pier. All oyster structures are within the 6.5 acres of federally owned, designated submerged lands immediately adjacent to Fort Norfolk. BMP's and turbidity curtains shall be used during the construction of the project to minimize impacts to those reefs.

### Impacts to Prey Species

Impacts to migration and spawning of prey species can lead to indirect adverse impacts to EFH designated for bluefish, summer flounder, windowpane flounder, and other piscivorous fishes that feed on anadromous fishes migrating through the Action Area. The extent of the turbidity plume in the Project Area is expected to be minor due to the high density of the local sediment material and high fall rate. The Action Area is on the edge of the Elizabeth River; with a width of 2,300 feet at the project area which allows for migrating prey species to continue to migrate around the pile driving site.

Benthic impacts from dredging activities will likely result in some mortality of benthic prey species consumed by managed fishes, but it is likely that these prey species would quickly re-colonize the area following dredging events and essential habitats would return to their current state. While we would anticipate impacts to managed species as a result of driving piles at the site, impacts are anticipated to be minor and temporary in nature.

### Fill

The fill material being placed is steel pipe piles and timber piles at the project site. There will also be concrete fill placed within a portion of the piles. There are currently (8) 18" x ½" piles which are proposed to be filled with concrete. This results in a total of 3.87CY of concrete fill. The total fill including all types of fill mentioned above is approximately 166CY.



## EFH Mapper Report

### EFH Data Notice

Essential Fish Habitat (EFH) is defined by textual descriptions contained in the fishery management plans developed by the regional fishery management councils. In most cases mapping data can not fully represent the complexity of the habitats that make up EFH. This report should be used for general interest queries only and should not be interpreted as a definitive evaluation of EFH at this location. A location-specific evaluation of EFH for any official purposes must be performed by a regional expert. Please refer to the following links for the appropriate regional resources.

[Greater Atlantic Regional Office](#)  
[Atlantic Highly Migratory Species Management Division](#)

### Query Results

Degrees, Minutes, Seconds: Latitude = 36° 51' 26" N, Longitude = 77° 41' 30" W  
 Decimal Degrees: Latitude = 36.857, Longitude = -76.308





The query location intersects with spatial data representing EFH and/or HAPCs for the following species/management units.

### \*\*\* WARNING \*\*\*

Please note under "Life Stage(s) Found at Location" the category "ALL" indicates that all life stages of that species share the same map and are designated at the queried location.

### EFH



Link	Data Caveats	Species/Management Unit	Lifestage(s) Found at Location	Management Council	FMP
		Little Skate	Adult	New England	Amendment 2 to the Northeast Skate Complex FMP
		Atlantic Herring	Juvenile Adult	New England	Amendment 3 to the Atlantic Herring FMP
		Red Hake	Adult Eggs/Larvae/Juvenile	New England	Amendment 14 to the Northeast Multispecies FMP
		Winter Skate	Adult	New England	Amendment 2 to the Northeast Skate Complex FMP
		Clearnose Skate	Adult Juvenile	New England	Amendment 2 to the Northeast Skate Complex FMP
		Windowpane Flounder	Juvenile	New England	Amendment 14 to the Northeast Multispecies FMP
		Bluefish	Adult Juvenile	Mid-Atlantic	Bluefish
		Atlantic Butterfish	Adult Juvenile	Mid-Atlantic	Atlantic Mackerel, Squid,& Butterfish Amendment 11

Link	Data Caveats	Species/Management Unit	Lifestage(s) Found at Location	Management Council	FMP
		Summer Flounder	Larvae Juvenile Adult	Mid-Atlantic	Summer Flounder, Scup, Black Sea Bass
		Black Sea Bass	Juvenile Adult	Mid-Atlantic	Summer Flounder, Scup, Black Sea Bass

### Salmon EFH

No Pacific Salmon Essential Fish Habitat (EFH) were identified at the report location.

### HAPCs

Link	Data Caveats	HAPC Name	Management Council
		Summer Flounder	Mid-Atlantic

### EFH Areas Protected from Fishing

No EFH Areas Protected from Fishing (EFHA) were identified at the report location.

**Spatial data does not currently exist for all the managed species in this area. The following is a list of species or management units for which there is no spatial data.**

**\*\*For links to all EFH text descriptions see the complete data inventory: [open data inventory -->](#)**

**All spatial data is currently available for the Mid-Atlantic and New England councils,**

**Secretarial EFH,**

Bigeye Sand Tiger Shark,

Bigeye Sixgill Shark,

Caribbean Sharpnose Shark,

Galapagos Shark,

Narrowtooth Shark,

Sevengill Shark,

Sixgill Shark,

Smooth Hammerhead Shark,

Smalltail Shark

## **NAO Pier Rehabilitation and Improvements Project**

### **Appendix A: Project Purpose and Description**

This project proposes to rehabilitate the existing pier at Fort Norfolk. The primary goal of the project is to modify the existing pier to allow for the safe mooring of three 65 feet (ft) vessels at Fort Norfolk and protect the mooring location from wave action and severe storm events.

Currently, the existing pier is not an adequate mooring location in moderate to severe weather situations in conjunction with simultaneous high tides. During these storm events with the current state of the pier, the vessels are relocated to other facilities for the duration of the storm event. As a result, the vessels may not be able to access the port for multiple days before or after a storm event, preventing the USACE from performing crucial port and channel surveys required for maintaining navigable waterways.

The north side of the pier will be developed with a floating mooring system to allow for minimal adjustments of mooring lines during tidal fluctuations. A "main" floating dock with two finger floating docks (three slips) will be installed. The freeboard of the docks will be 30 inches (in) (maximum for stability). The pier will be modified for new utilities as well as raised to accommodate for rising tide levels and a new gangway. None of the existing pilings have been treated with creosote.

The main floating dock and two floating dock fingers (three slips) will be accessed by a small 8 ft x 16 ft platform and a 6 ft x 60 ft aluminum gangway. The main floating dock is 30 ft wide and 60 ft long. The two finger floating docks are 20 ft and 80 ft wide and 240 ft long, respectively. The main floating dock and finger floating docks will be made of concrete. Twenty-two new 30-in diameter hollow, steel pipe piles will be installed to anchor the floating docks. Four new 30-in diameter hollow, steel pipe monopiles with donut fenders attached will be installed on the waterward side of two of the slips to protect the vessels and aid in mooring. The platform will be supported by four 18-in diameter partially concrete filled, steel pipe piles.

A steel breakwater wave screen will be installed to the west and perpendicular of the pier to protect the dock system from wave action. The wave screen will consist of two legs, joined at approximately a 120-degree angle. The shorter of the two legs will be 90 ft long and the longer of the two will be 220 ft long. Twenty-one 30-in diameter steel pipe piles will support the screen. The wave screen will have a 3 ft-high opening at the bottom. All 64 piles, including steel and timber, will be advanced using a vibratory hammer and a soft start. Eight of the steel piles will be driven with an impact hammer for the final approximately 10 ft of depth to confirm the axial capacities have been reached.

A new timber wave fence will be installed on the existing timber fender. 335 linear feet (LF) of timber wave fence will be installed along the south side of the existing pier. The wave fence will have a 3 ft-high opening at the bottom. Off the southwest corner of the pier, the wave screen will be extended another 45 LF using three 30-inch-diameter steel pipe piles to support the screen.

There will be two steel monopiles with floating donut fenders, one at the west end of the 45 LF of new wave screen and the other at the south end of the short 90 LF segment of the larger wave screen. These monopiles will be separate by approximately 53 ft-4 in to create the opening of the basin.

The existing pier deck will be raised by the addition of new steel beams to protect the deck from flooding. The new deck elevation will be approximately 2 ft higher than the current elevation. A new ramp will be installed to access the raised deck. Pier raising will be done by building a secondary deck atop the existing pier. Wide flange steel beams will be used to increase the height and a fiberglass grating will be used for the new deck surface. New concrete edge beams will be poured atop the perimeter of the pier and will include scuppers to handle drainage. All concrete pouring will take place above the water on the existing structure.

Additionally, on the south side of the pier, a new boat lift for a Boston whaler vessel is proposed. The lift will be supported by four 12-inch-diameter timber piles.



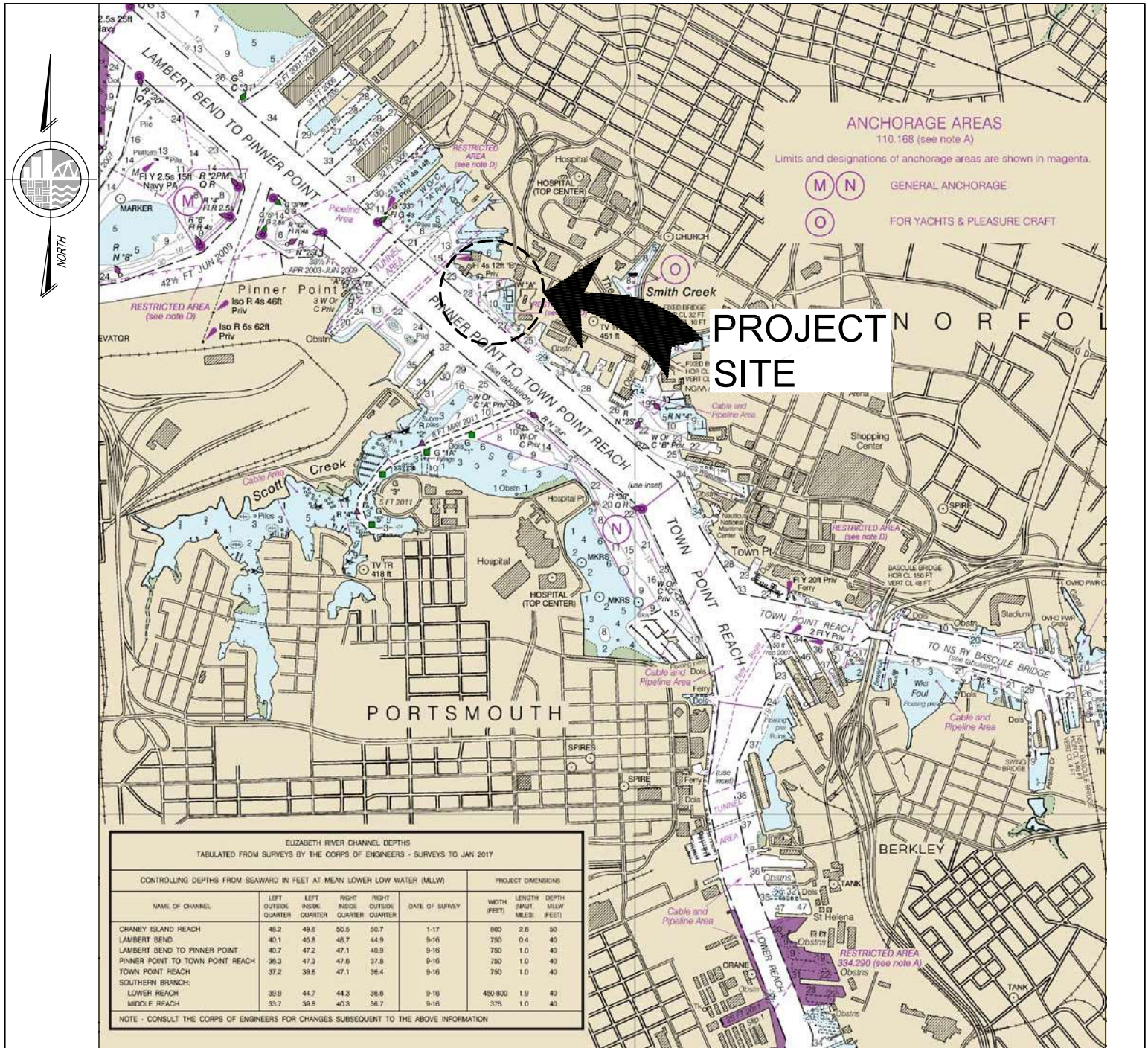

## SITE LOCATION MAP

N.T.S.

DATUM: NAVD88

### NAO PIER - SMALL CRAFT HARBOR

ADJACENT OWNERS:

- REFER TO SECTION 14 OF THE JOINT PERMIT APPLICATION FOR THE LIST OF ADJACENT PROPERTY OWNERS.

APPLICANT: Lesley Dobbins-Noble  
United States Army Corps Of Engineers  
Norfolk District 803 Front St.  
Norfolk, VA 23510

AGENT: M.G. McLaren Engineering  
and Land Surveying, P.C.  
530 Chestnut Ridge Rd.  
Woodcliff Lake, NJ 07677

### SITE LOCATION MAP

IN: ELIZABETH RIVER  
AT: NORFOLK (NORFOLK HARBOR)  
COUNTY OF: NORFOLK STATE: VA

SHT 1 OF 16

11/20/21



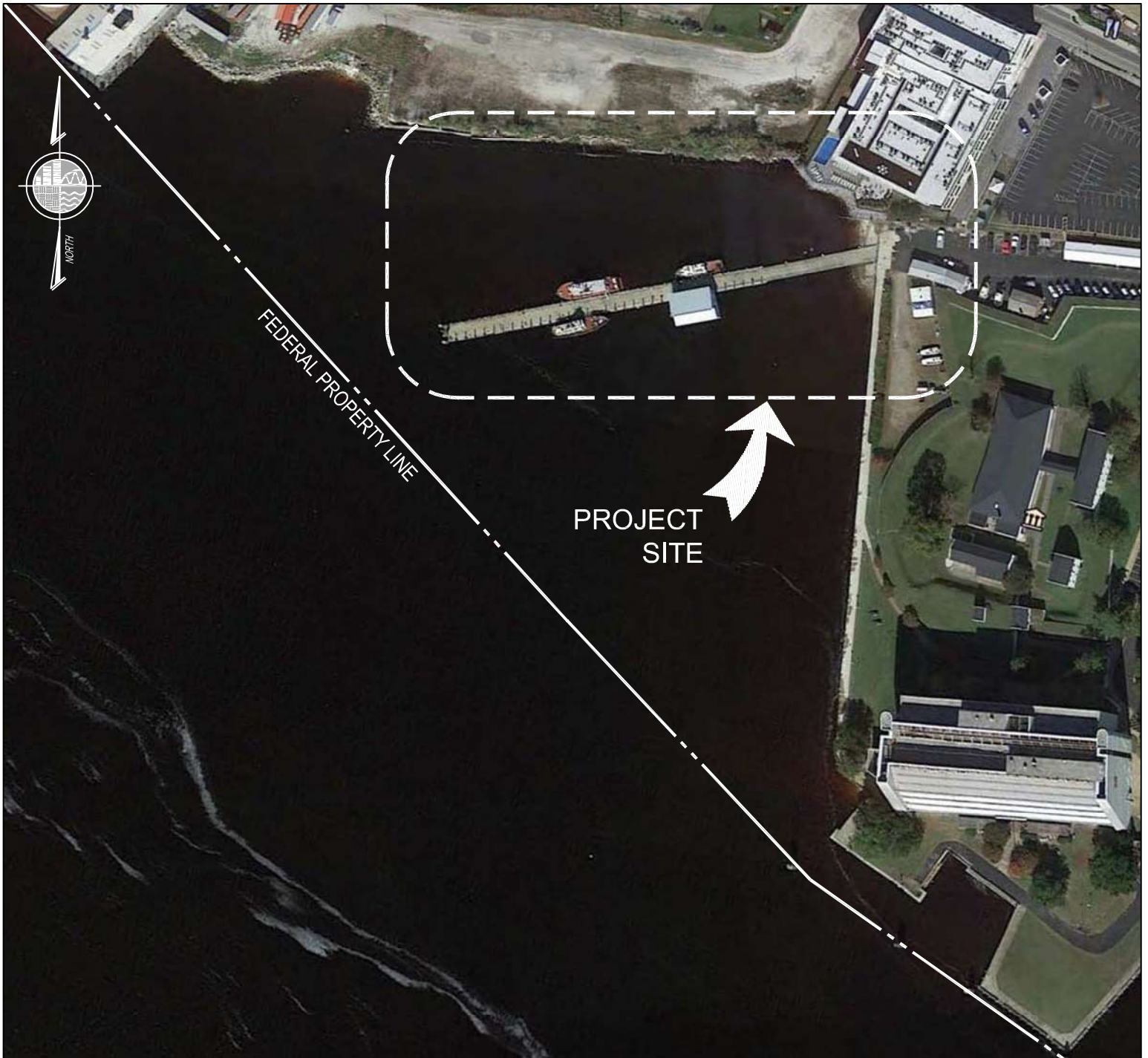

## SITE VICINITY MAP

N.T.S.

DATUM: NAVD88

ADJACENT OWNERS:  
 1. REFER TO SECTION 14 OF THE JOINT PERMIT APPLICATION FOR THE LIST OF ADJACENT PROPERTY OWNERS.

### NAO PIER - SMALL CRAFT HARBOR

APPLICANT: Lesley Dobbins-Noble  
 United States Army Corps Of Engineers  
 Norfolk District 803 Front St.  
 Norfolk, VA 23510

AGENT: M.G. McLaren Engineering  
 and Land Surveying, P.C.  
 530 Chestnut Ridge Rd.  
 Woodcliff Lake, NJ 07677

### SITE VICINITY MAP

IN: ELIZABETH RIVER  
 AT: NORFOLK (NORFOLK HARBOR)  
 COUNTY OF: NORFOLK STATE: VA

SHT 2 OF 16

11/20/21

## TIDAL DATA

BASED ON DATA PUBLISHED BY NOAA. PUBLICATION DATE  
10/20/17.  
FOR TIDAL EPOCH 1983 - 2001.

	NATIONAL GEODETIC VERTICAL DATUM OF 1929 (NGVD 29)	MEAN-LOW-WATER DATUM
100 YR. FLOOD LEVEL 3 HURRICANE	10.00	11.66
HIGHEST OBSERVED (HOWL)	4.62	6.28
PLATFORM DECK (TYP.)	4.24	5.90
SPRING HIGH TIDE (SHT)	1.37	3.03
MEAN HIGH HIGH WATER (MHHW)	1.24	2.90
MEAN HIGH WATER (MHW)	0.99	2.65
NGVD OF 1929 (NGVD 29)	0.00	1.66
MEAN LOW WATER (MLW)	-1.66	0.00
MEAN LOW LOW WATER (MLLW)	-1.79	-0.13
LOWEST OBSERVED (LOWL)	-3.28	-1.62

**NOTES:**

1. DATUMS FOR ELIZABETH RIVER (NORFOLK HARBOR) VA.
2. ALL ELEVATIONS ARE IN FEET.

## TIDAL DATUM

N.T.S.

DATUM: NAVD88

### NAO PIER - SMALL CRAFT HARBOR

### TIDAL DATUM

**ADJACENT OWNERS:**

1. REFER TO SECTION 14 OF THE JOINT PERMIT APPLICATION FOR THE LIST OF ADJACENT PROPERTY OWNERS.

**APPLICANT:** Lesley Dobbins-Noble  
United States Army Corps Of Engineers  
Norfolk District 803 Front St.  
Norfolk, VA 23510

**AGENT:** M.G. McLaren Engineering  
and Land Surveying, P.C.  
530 Chestnut Ridge Rd.  
Woodcliff Lake, NJ 07677

IN: ELIZABETH RIVER  
AT: NORFOLK (NORFOLK HARBOR)  
COUNTY OF: NORFOLK STATE: VA

SHT 3 OF 16

11/20/21

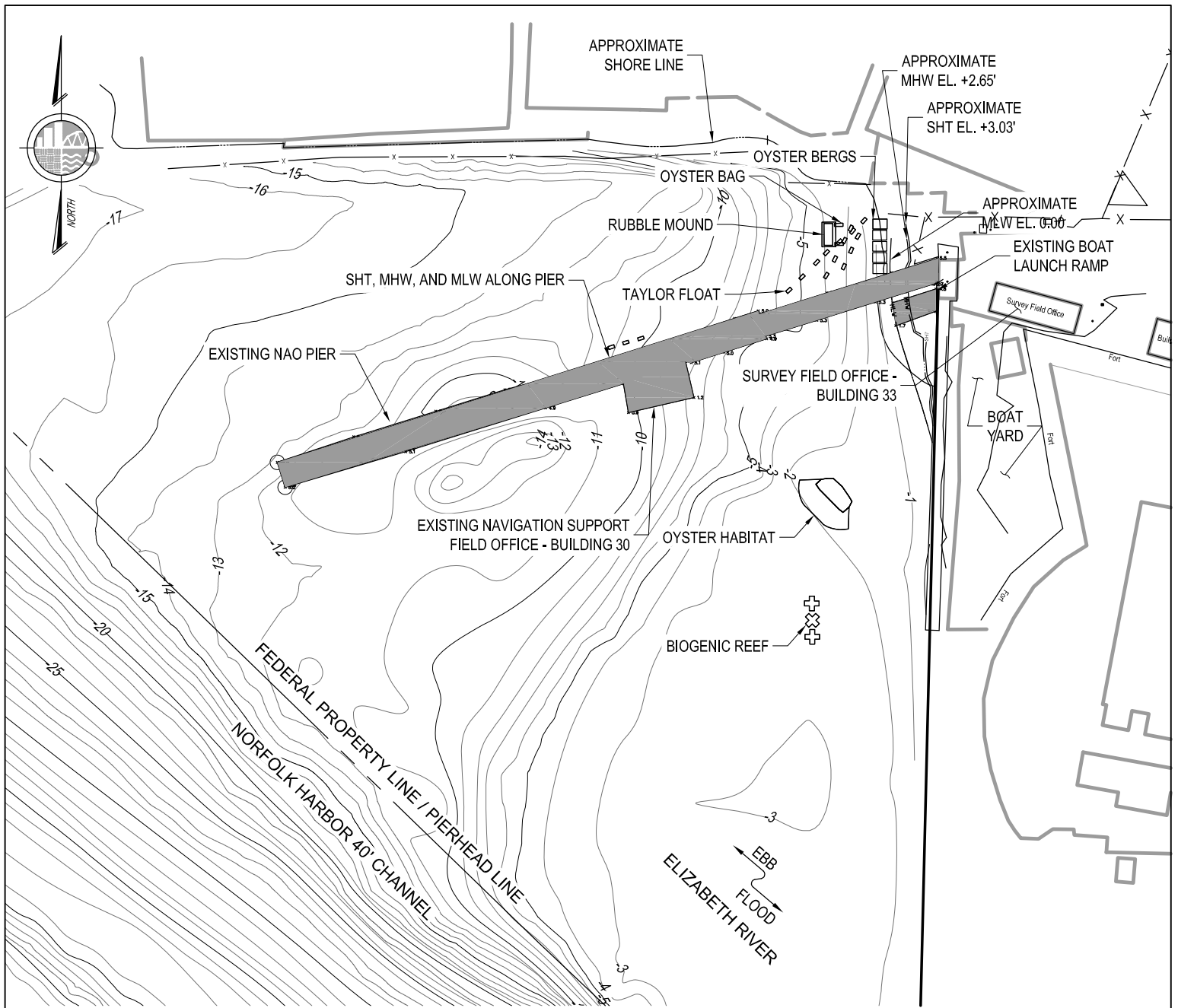

**4** **EXISTING SITE PLAN**

NOTE:  
1. REFERENCE DATUM IS TO MEAN LOW WATER (MLW).

DATUM: NAVD88

ADJACENT OWNERS:  
1. REFER TO SECTION 14 OF THE JOINT PERMIT APPLICATION FOR THE LIST OF ADJACENT PROPERTY OWNERS.

**NAO PIER - SMALL CRAFT HARBOR**

APPLICANT: Lesley Dobbins-Noble  
United States Army Corps Of Engineers  
Norfolk District 803 Front St.  
Norfolk, VA 23510  
AGENT: M.G. McLaren Engineering  
and Land Surveying, P.C.  
530 Chestnut Ridge Rd.  
Woodcliff Lake, NJ 07677

**EXISTING SITE PLAN**

IN: ELIZABETH RIVER  
AT: NORFOLK (NORFOLK HARBOR)  
COUNTY OF: NORFOLK STATE: VA

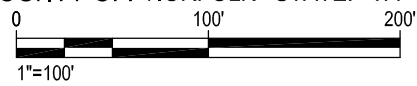

SHT 4 OF 16 11/20/21



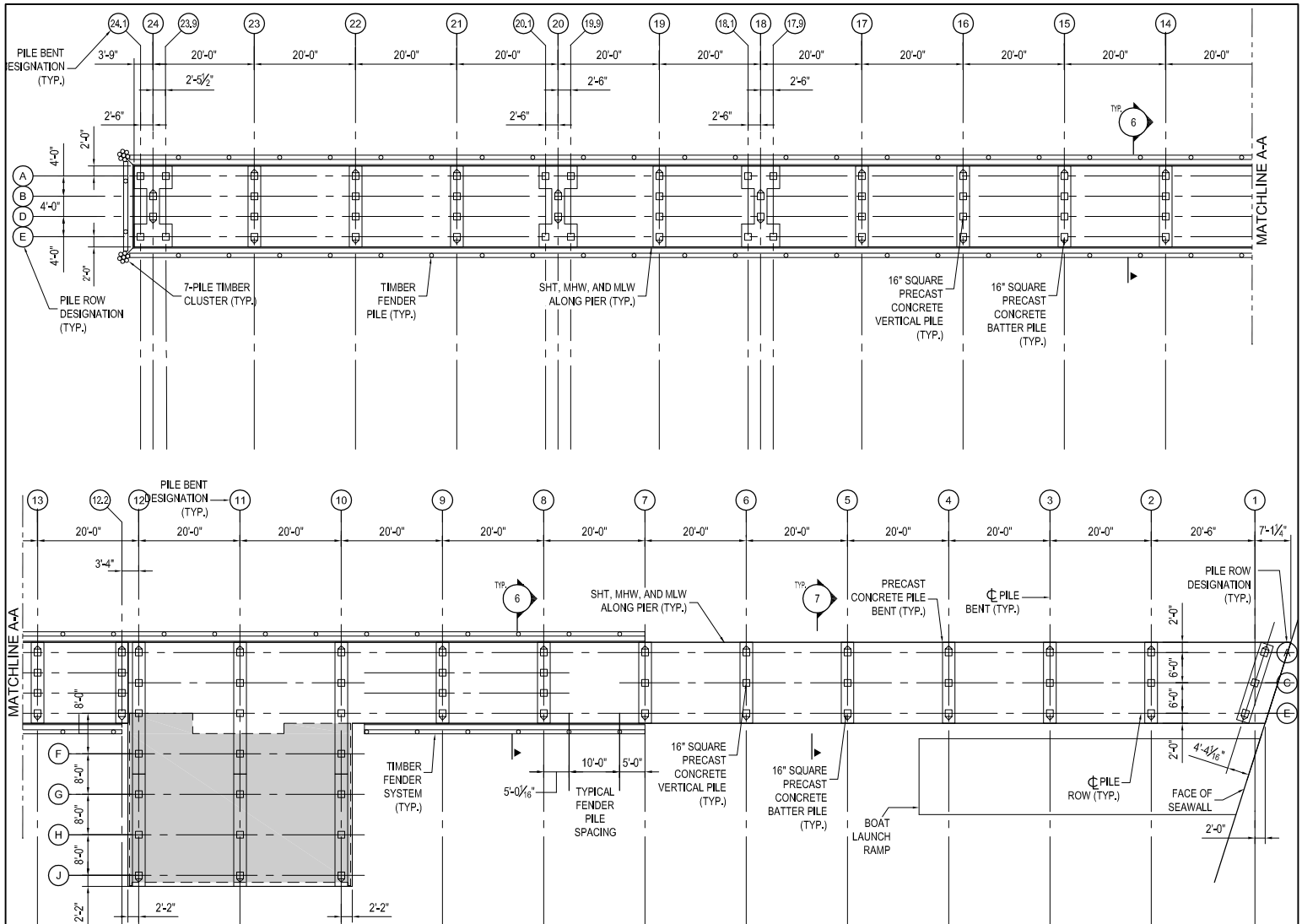

**5** **EXISTING PIER PILE PLAN**  
 1/32"=1'-0"



DATUM: NAVD88

ADJACENT OWNERS:  
 1. REFER TO SECTION 14 OF THE JOINT PERMIT APPLICATION FOR THE LIST OF ADJACENT PROPERTY OWNERS.

**NAO PIER - SMALL CRAFT HARBOR**

APPLICANT: Lesley Dobbins-Noble  
 United States Army Corps Of Engineers  
 Norfolk District 803 Front St.  
 Norfolk, VA 23510  
 AGENT: M.G. McLaren Engineering  
 and Land Surveying, P.C.  
 530 Chestnut Ridge Rd.  
 Woodcliff Lake, NJ 07677

**EXISTING PIER PILE PLAN**

IN: ELIZABETH RIVER  
 AT: NORFOLK (NORFOLK HARBOR)  
 COUNTY OF: NORFOLK STATE: VA



SHT 5 OF 16

11/20/21

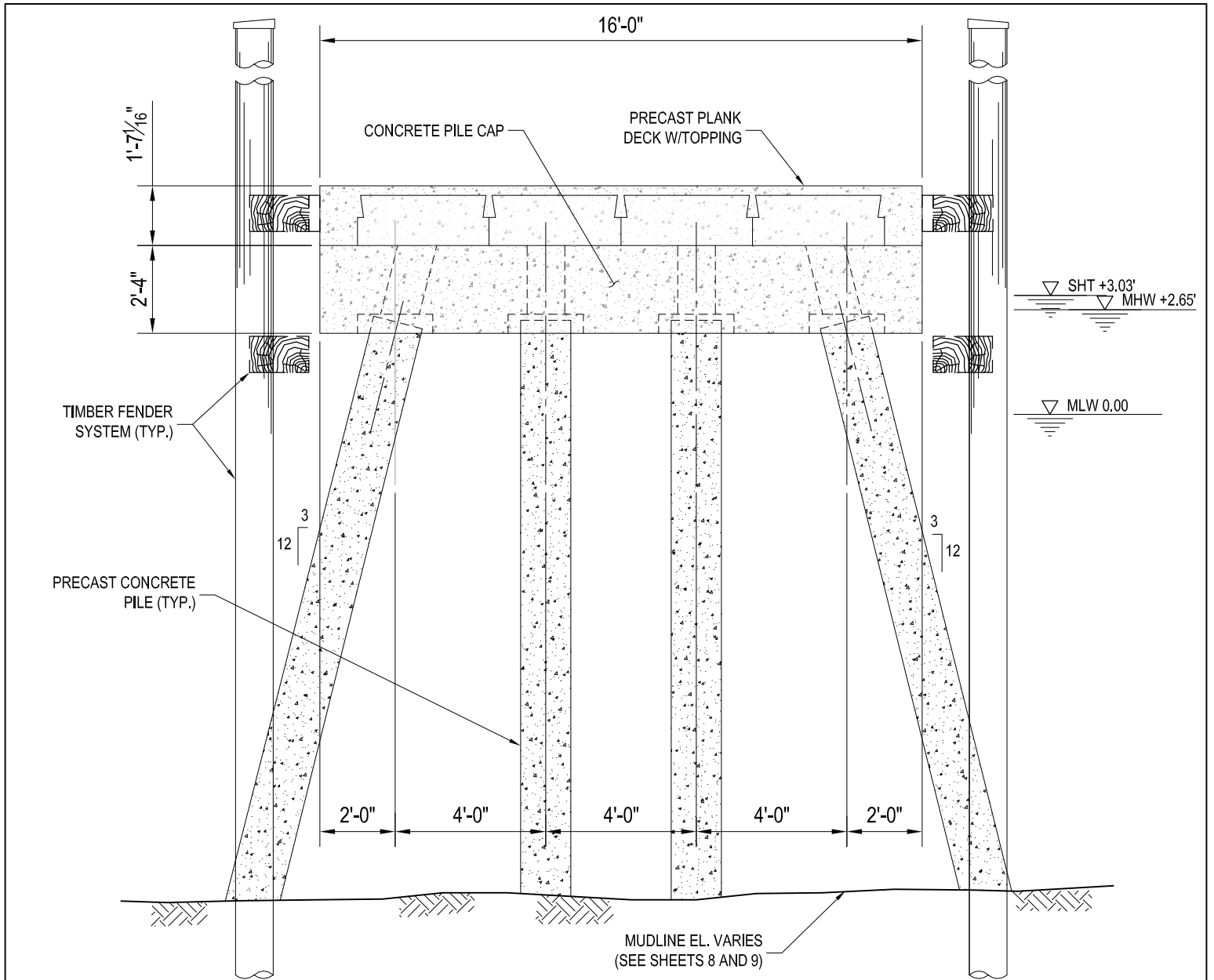

**6 EXISTING TYPICAL BENT CONFIGURATION**

NOTE:  
1. REFERENCE DATUM IS TO MEAN LOW WATER (MLW).

1/4"=1'-0"

DATUM: NAVD88

ADJACENT OWNERS:  
1. REFER TO SECTION 14 OF THE JOINT PERMIT APPLICATION FOR THE LIST OF ADJACENT PROPERTY OWNERS.

**NAO PIER - SMALL CRAFT HARBOR**

APPLICANT: Lesley Dobbins-Noble  
United States Army Corps Of Engineers  
Norfolk District 803 Front St.  
Norfolk, VA 23510  
AGENT: M.G. McLaren Engineering and Land Surveying, P.C.  
530 Chestnut Ridge Rd.  
Woodcliff Lake, NJ 07677

**EXISTING SECTIONS**

IN: ELIZABETH RIVER  
AT: NORFOLK (NORFOLK HARBOR)  
COUNTY OF: NORFOLK STATE: VA

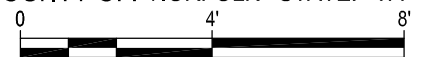

SHT 6 OF 16

11/20/21

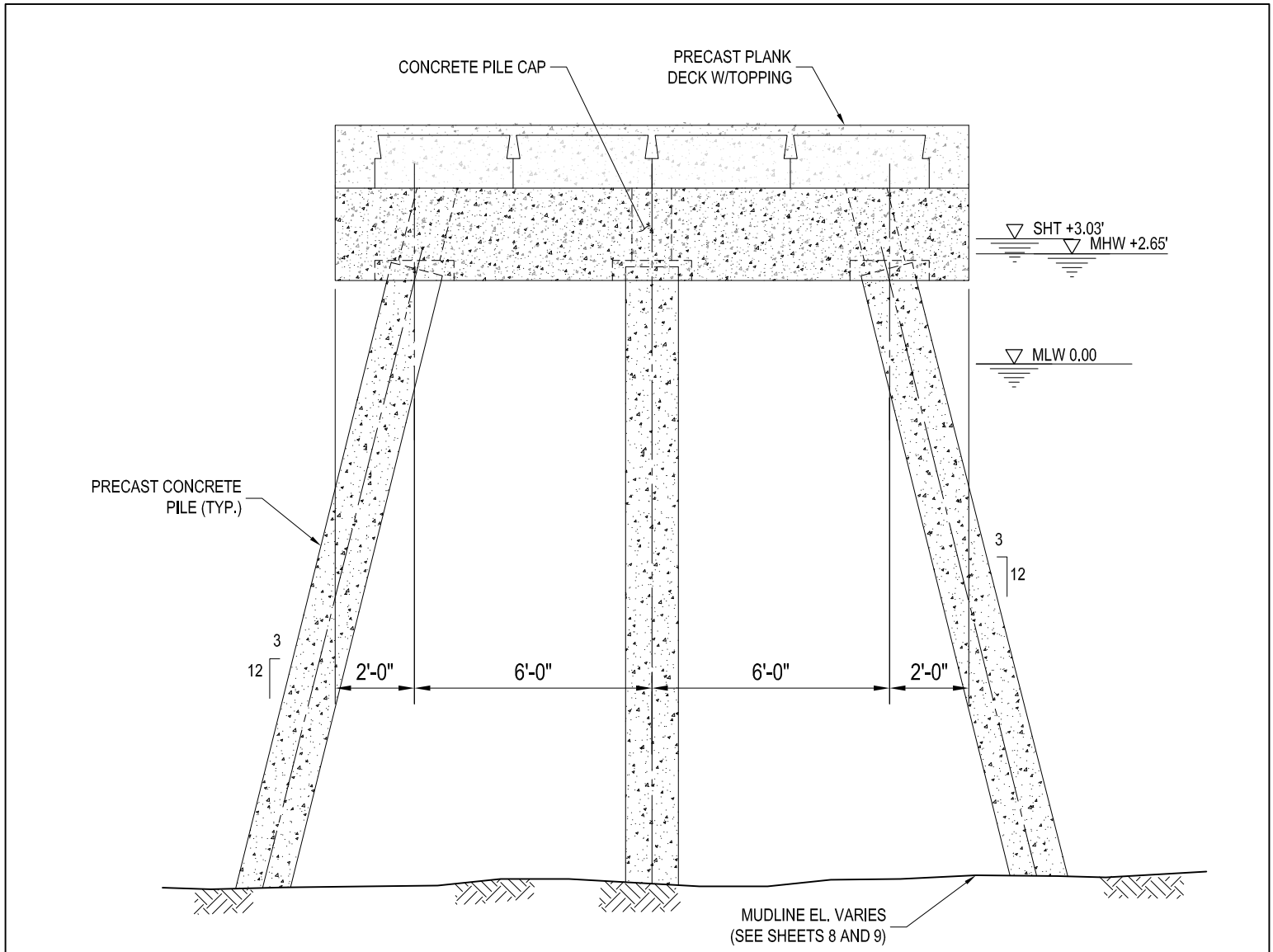

**7 EXISTING PIER RAMP BENT CONFIGURATION**  
 1/4"=1'-0"

- NOTES:  
 1. TYPICAL BENT CONFIGURATION FOR BENTS 1-7.  
 2. REFERENCE DATUM IS TO MEAN LOW WATER (MLW).

<p>DATUM: NAVD88</p> <p>ADJACENT OWNERS:          1. REFER TO SECTION 14 OF THE JOINT PERMIT APPLICATION FOR THE LIST OF ADJACENT PROPERTY OWNERS.</p>	<p><b>NAO PIER - SMALL CRAFT HARBOR</b></p> <p>APPLICANT: Lesley Dobbins-Noble          United States Army Corps Of Engineers          Norfolk District 803 Front St.          Norfolk, VA 23510</p> <p>AGENT: M.G. McLaren Engineering and Land Surveying, P.C.          530 Chestnut Ridge Rd.          Woodcliff Lake, NJ 07677</p>	<p><b>EXISTING SECTIONS</b></p> <p>IN: ELIZABETH RIVER          AT: NORFOLK (NORFOLK HARBOR)          COUNTY OF: NORFOLK STATE: VA</p> <p>0 4' 8'          1/4"=1'-0"</p> <p>SHT 7 OF 16 11/20/21</p>
--	--	---

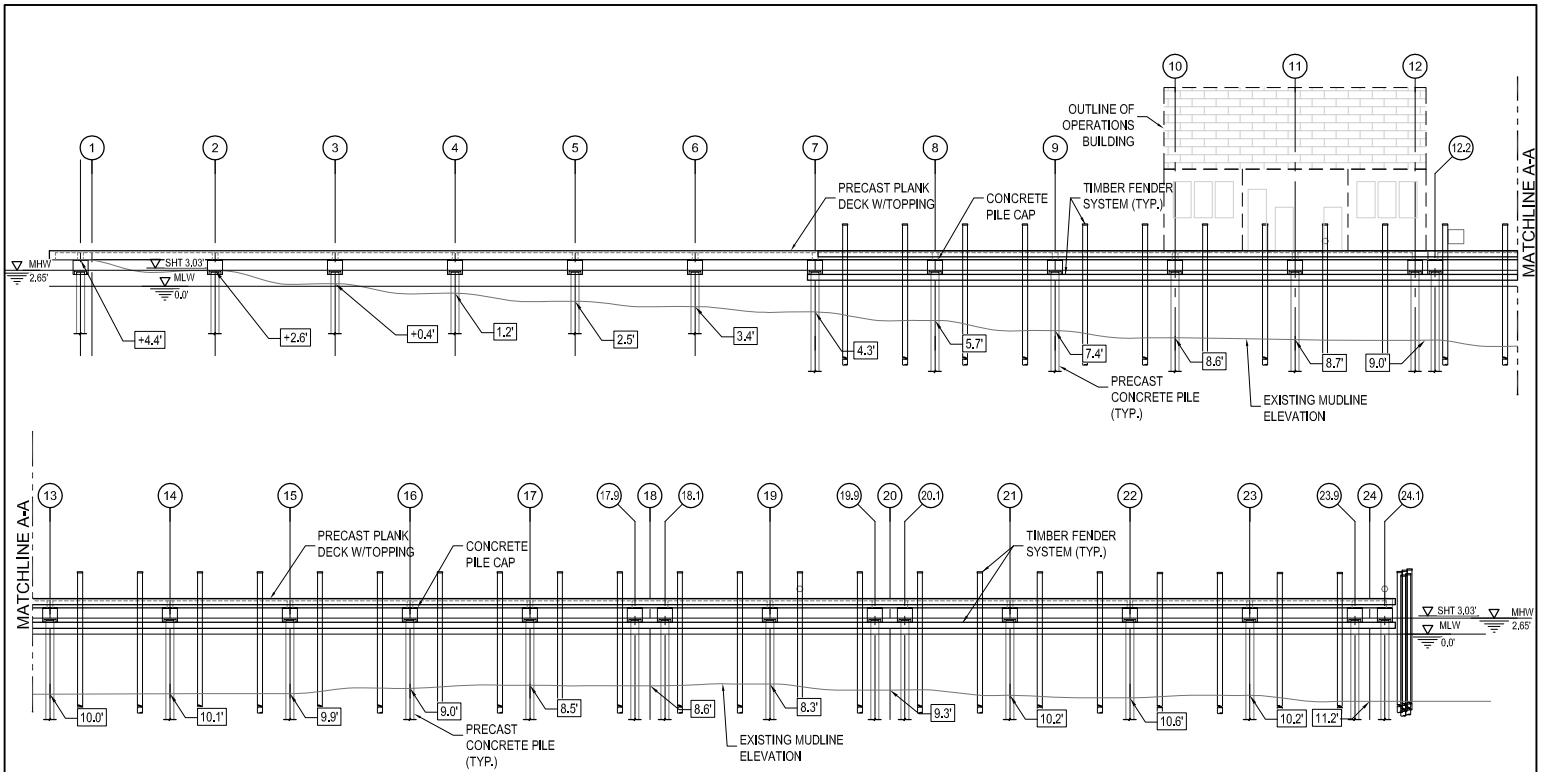

**PIER ELEVATION  
(LOOKING SOUTH)**

**8 EXISTING ELEVATIONS**  
1/32"=1'-0"

NOTE:  
1. REFERENCE DATUM IS TO MEAN LOW WATER (MLW).

LEGEND:

xx' MUDLINE ELEVATION BELOW MEAN-LOW-WATER

① PILE BENT IDENTIFICATION

DATUM: NAVD88

ADJACENT OWNERS:  
1. REFER TO SECTION 14 OF THE JOINT PERMIT APPLICATION FOR THE LIST OF ADJACENT PROPERTY OWNERS.

**NAO PIER - SMALL CRAFT HARBOR**

APPLICANT: Lesley Dobbins-Noble  
United States Army Corps Of Engineers  
Norfolk District 803 Front St.  
Norfolk, VA 23510  
AGENT: M.G. McLaren Engineering and Land Surveying, P.C.  
530 Chestnut Ridge Rd.  
Woodcliff Lake, NJ 07677

**EXISTING ELEVATIONS**

IN: ELIZABETH RIVER  
AT: NORFOLK (NORFOLK HARBOR)  
COUNTY OF: NORFOLK STATE: VA

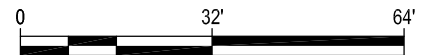

SHT 8 OF 16

11/20/21

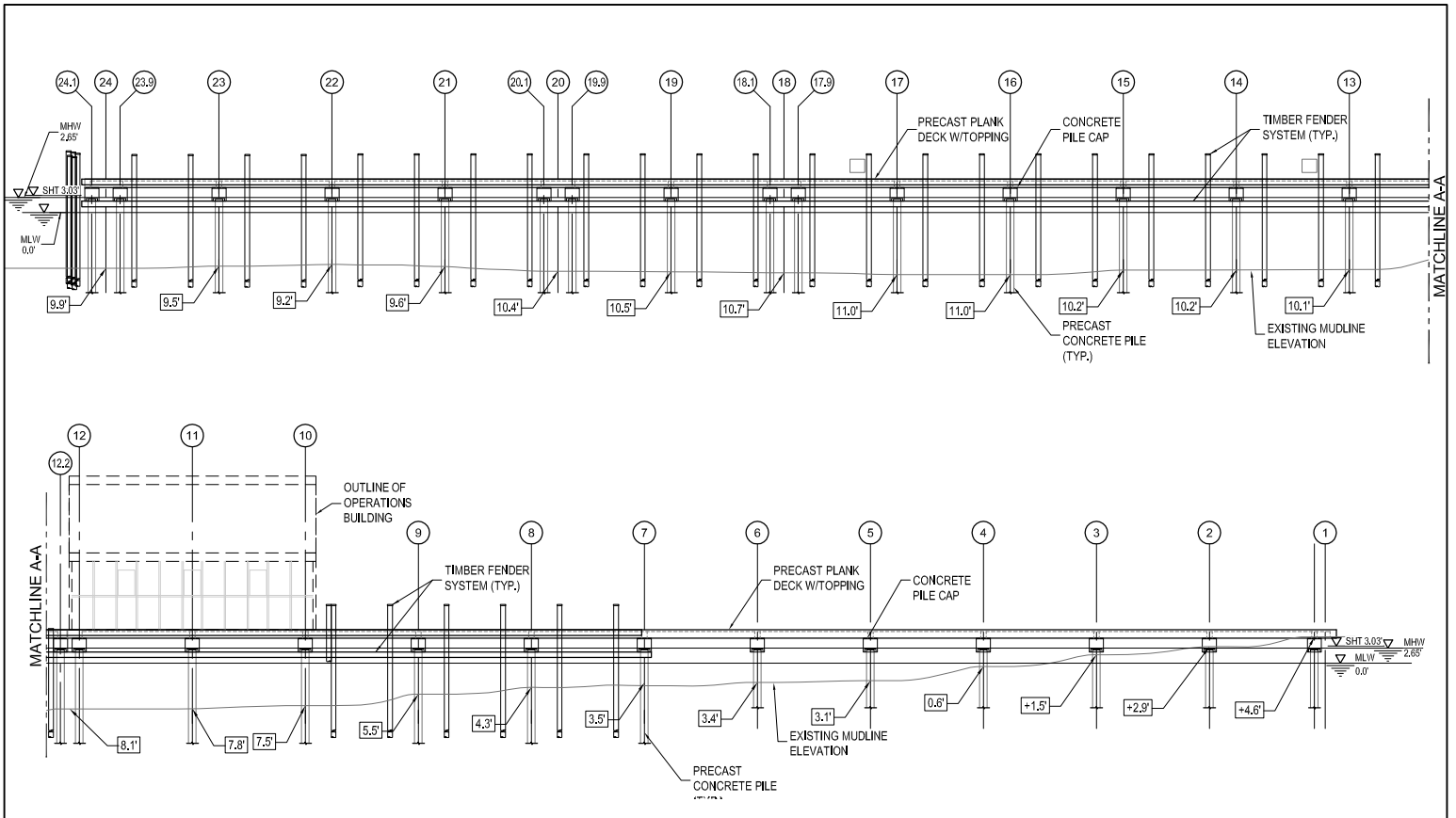

**PIER ELEVATION  
(LOOKING NORTH)**

**9 EXISTING ELEVATIONS**  
1/32"=1'-0"

**NOTE:**  
1. REFERENCE DATUM IS TO MEAN LOW WATER (MLW).

- LEGEND:**
- x.x MUDLINE ELEVATION BELOW MEAN-LOW-WATER
  - ① PILE BENT IDENTIFICATION

DATUM: NAVD88

ADJACENT OWNERS:  
1. REFER TO SECTION 14 OF THE JOINT PERMIT APPLICATION FOR THE LIST OF ADJACENT PROPERTY OWNERS.

**NAO PIER - SMALL CRAFT HARBOR**

APPLICANT: Lesley Dobbins-Noble  
United States Army Corps Of Engineers  
Norfolk District 803 Front St.  
Norfolk, VA 23510  
AGENT: M.G. McLaren Engineering and Land Surveying, P.C.  
530 Chestnut Ridge Rd.  
Woodcliff Lake, NJ 07677

**EXISTING ELEVATIONS**

IN: ELIZABETH RIVER  
AT: NORFOLK (NORFOLK HARBOR)  
COUNTY OF: NORFOLK STATE: VA  
0 32' 64'  
1/32"=1'-0"  
SHT 9 OF 16 11/20/21

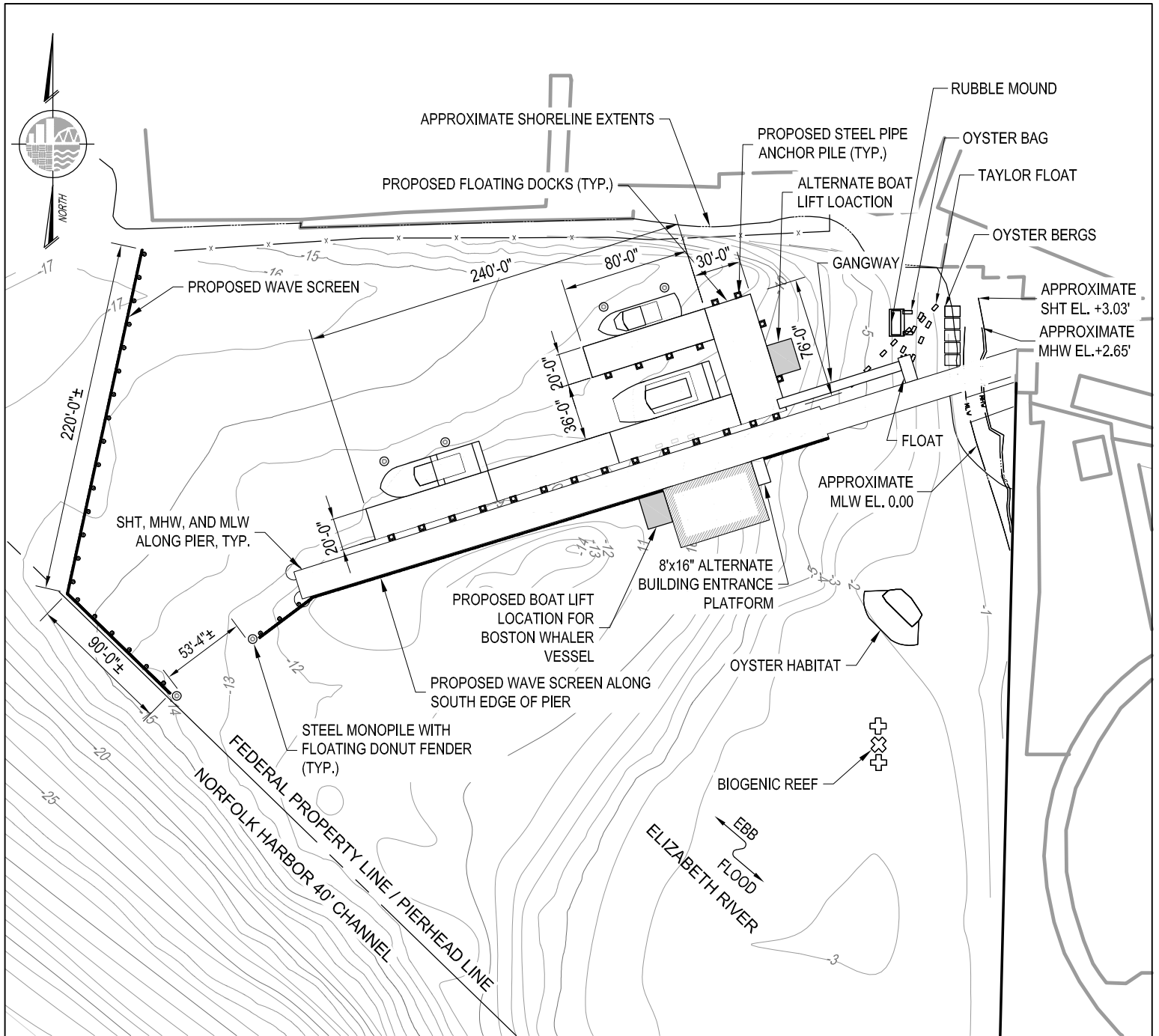

**10 PROPOSED SITE PLAN**

NOTE:  
1. REFERENCE DATUM IS TO MEAN LOW WATER (MLW).

1"=90'-0"

DATUM: NAVD88

ADJACENT OWNERS:  
1. REFER TO SECTION 14 OF THE JOINT PERMIT APPLICATION FOR THE LIST OF ADJACENT PROPERTY OWNERS.

**NAO PIER - SMALL CRAFT HARBOR**

APPLICANT: Lesley Dobbins-Noble  
United States Army Corps Of Engineers  
Norfolk District 803 Front St.  
Norfolk, VA 23510  
AGENT: M.G. McLaren Engineering  
and Land Surveying, P.C.  
530 Chestnut Ridge Rd.  
Woodcliff Lake, NJ 07677

**PROPOSED SITE PLAN**

IN: ELIZABETH RIVER  
AT: NORFOLK (NORFOLK HARBOR)  
COUNTY OF: NORFOLK STATE: VA

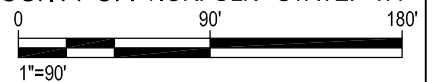

SHT 10 OF 16

11/20/21

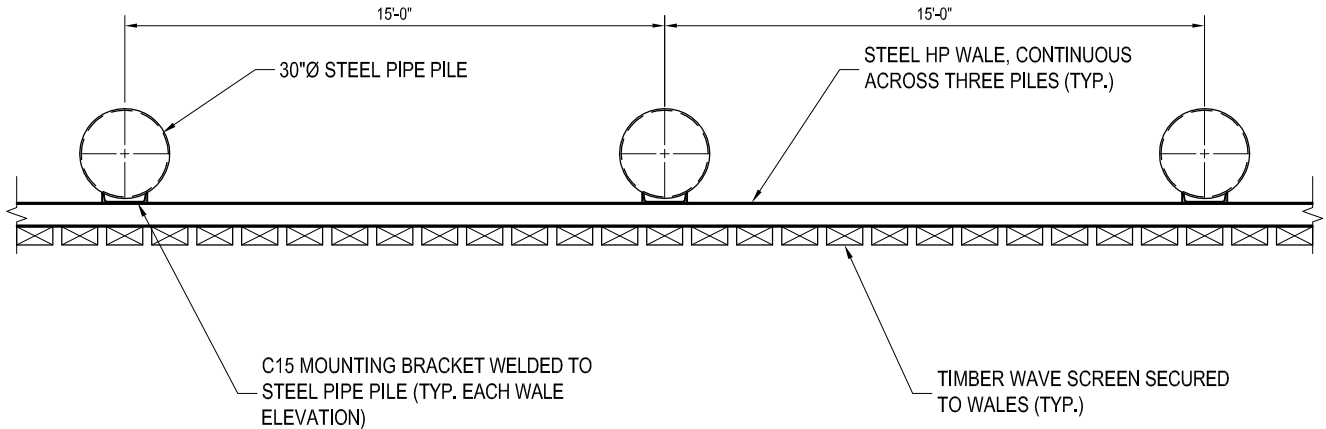

11

**STEEL BREAKWATER PART PLAN**

3/16"=1'-0"

DATUM: NAVD88

ADJACENT OWNERS:  
1. REFER TO SECTION 14 OF THE JOINT PERMIT APPLICATION FOR THE LIST OF ADJACENT PROPERTY OWNERS.

**NAO PIER - SMALL CRAFT HARBOR**

APPLICANT: Lesley Dobbins-Noble  
United States Army Corps Of Engineers  
Norfolk District 803 Front St.  
Norfolk, VA 23510  
AGENT: M.G. McLaren Engineering and Land Surveying, P.C.  
530 Chestnut Ridge Rd.  
Woodcliff Lake, NJ 07677

**WAVE SCREEN PART PLAN**

IN: ELIZABETH RIVER  
AT: NORFOLK (NORFOLK HARBOR)  
COUNTY OF: NORFOLK STATE: VA

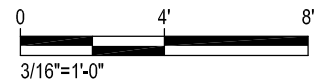

SHT 11 OF 16

11/20/21

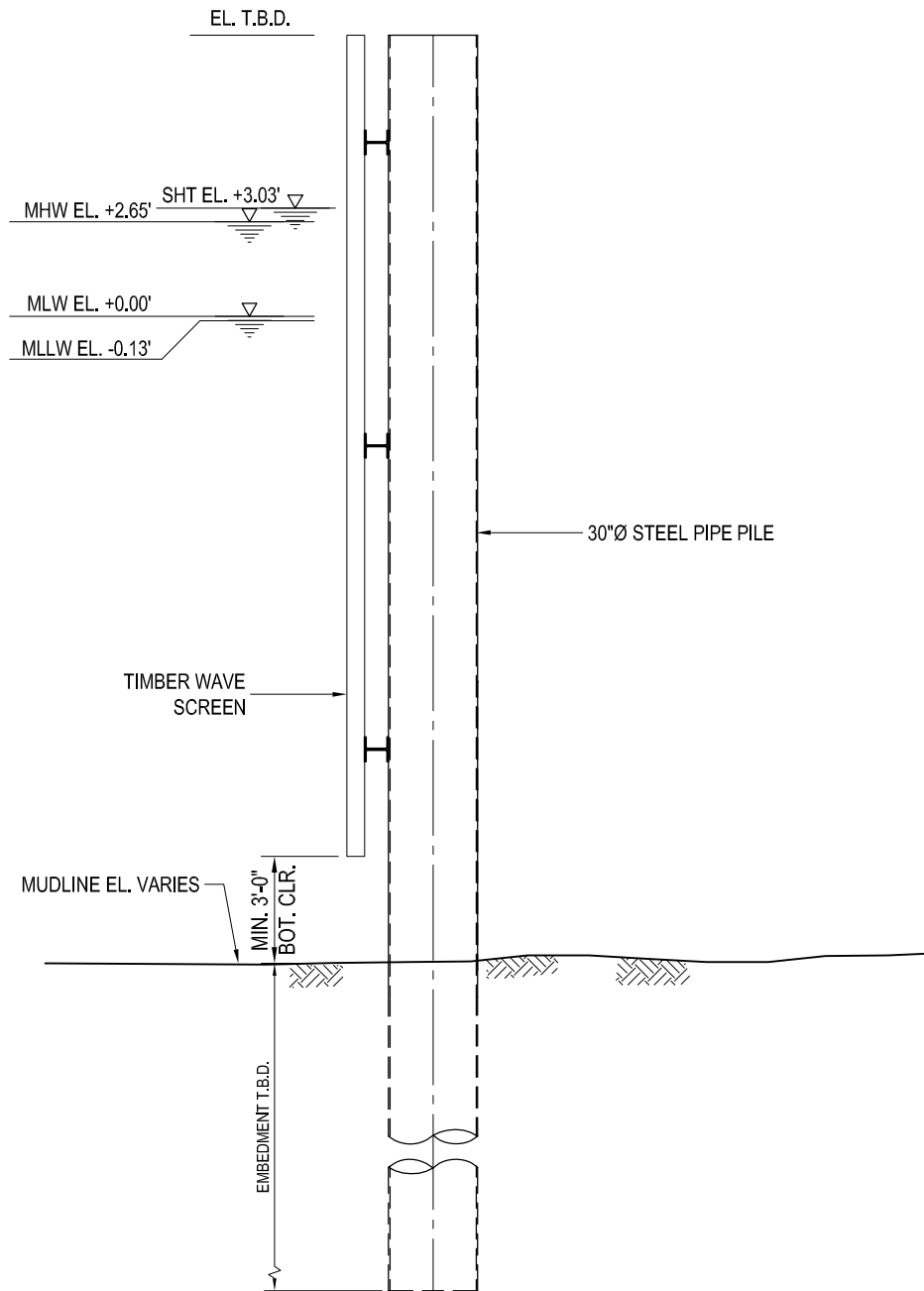

**12 STEEL BREAKWATER SECTION** 3/16"=1'-0"

NOTE:  
1. REFERENCE DATUM IS TO MEAN LOW WATER (MLW).

<p>DATUM: NAVD88</p> <p>ADJACENT OWNERS: 1. REFER TO SECTION 14 OF THE JOINT PERMIT APPLICATION FOR THE LIST OF ADJACENT PROPERTY OWNERS.</p>	<p><b>NAO PIER - SMALL CRAFT HARBOR</b></p> <p>APPLICANT: Lesley Dobbins-Noble United States Army Corps Of Engineers Norfolk District 803 Front St. Norfolk, VA 23510</p> <p>AGENT: M.G. McLaren Engineering and Land Surveying, P.C. 530 Chestnut Ridge Rd. Woodcliff Lake, NJ 07677</p>	<p><b>WAVE SCREEN SECTION</b></p> <p>IN: ELIZABETH RIVER AT: NORFOLK (NORFOLK HARBOR) COUNTY OF: NORFOLK STATE: VA</p> <div style="text-align: center;"> <p>3/16"=1'-0"</p> </div> <p>SHT 12 OF 16 <span style="float: right;">11/20/21</span></p>
---	---	--



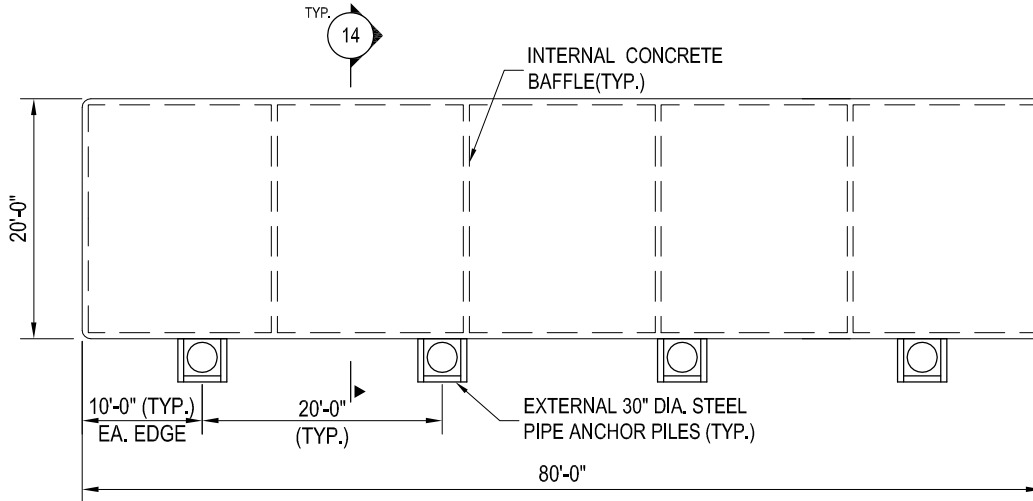

**13A TYPE 1 FLOATING DOCK PLAN**  
1/16"=1'-0"

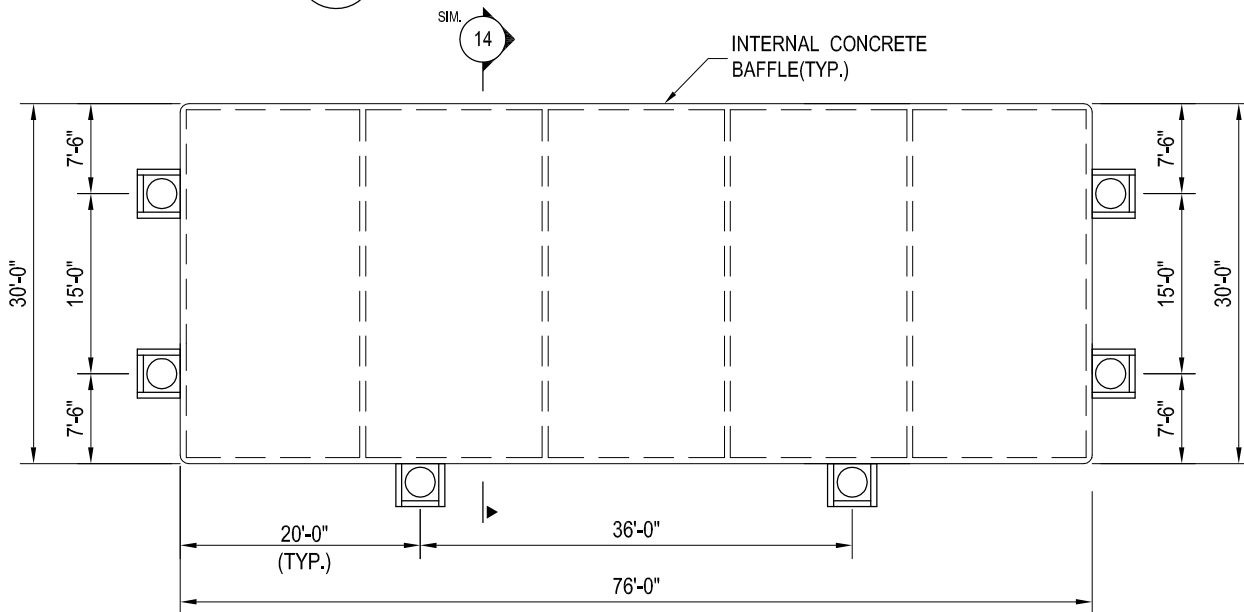

**13B TYPE 2 FLOATING DOCK PLAN**  
1/16"=1'-0"

**NOTE:**

- FLOAT BAFFLE LAYOUT AND GEOMETRY ARE APPROXIMATE. FINAL DESIGN TO BE PERFORMED BY MANUFACTURER AND SUBMITTED TO ENGINEER FOR REVIEW AND APPROVAL PRIOR TO PROCUREMENT.

DATUM: NAVD88

**ADJACENT OWNERS:**

- REFER TO SECTION 14 OF THE JOINT PERMIT APPLICATION FOR THE LIST OF ADJACENT PROPERTY OWNERS.

**NAO PIER - SMALL CRAFT HARBOR**

APPLICANT: Lesley Dobbins-Noble  
United States Army Corps Of Engineers  
Norfolk District 803 Front St.  
Norfolk, VA 23510  
AGENT: M.G. McLaren Engineering  
and Land Surveying, P.C.  
530 Chestnut Ridge Rd.  
Woodcliff Lake, NJ 07677

**FLOATING DOCK PLAN**

IN: ELIZABETH RIVER  
AT: NORFOLK (NORFOLK HARBOR)  
COUNTY OF: NORFOLK STATE: VA



SHT 13 OF 16

11/20/21

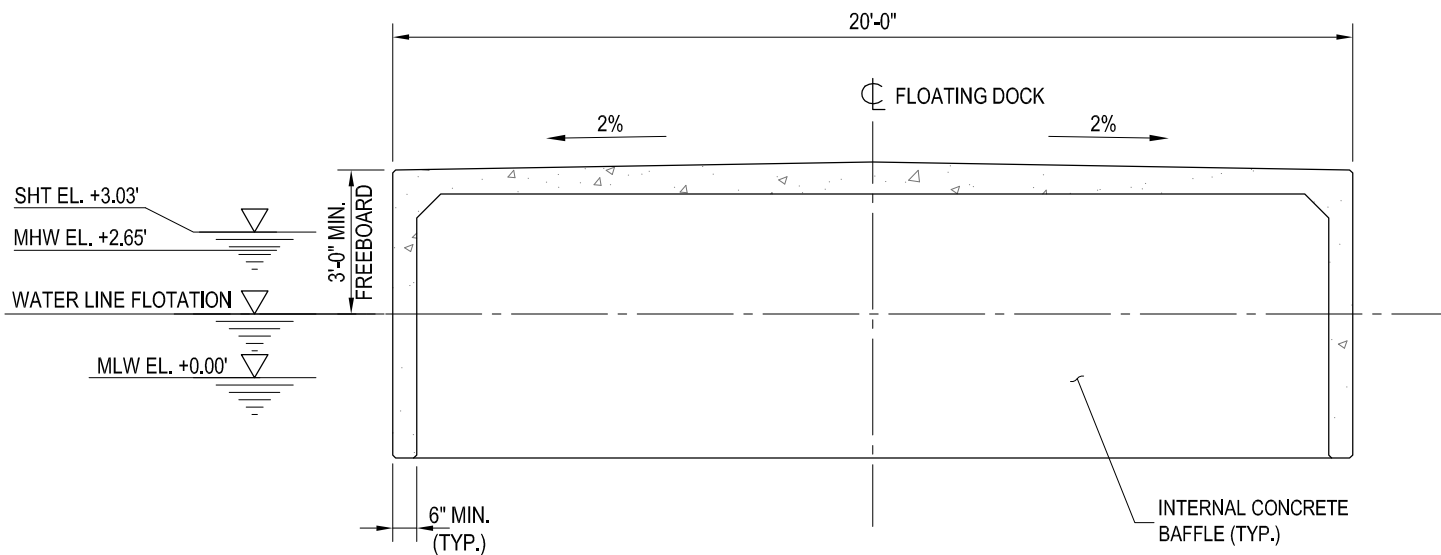

14

**FLOATING DOCK TYPICAL SECTION**

1/4"=1'-0"

**NOTE:**

- 1. REFERENCE DATUM IS TO MEAN LOW WATER (MLW).

DATUM: NAVD88

ADJACENT OWNERS:  
1. REFER TO SECTION 14 OF THE JOINT PERMIT APPLICATION FOR THE LIST OF ADJACENT PROPERTY OWNERS.

**NAO PIER - SMALL CRAFT HARBOR**

APPLICANT: Lesley Dobbins-Noble  
United States Army Corps Of Engineers  
Norfolk District 803 Front St.  
Norfolk, VA 23510  
AGENT: M.G. McLaren Engineering and Land Surveying, P.C.  
530 Chestnut Ridge Rd.  
Woodcliff Lake, NJ 07677

**FLOATING DOCK SECTION**

IN: ELIZABETH RIVER  
AT: NORFOLK (NORFOLK HARBOR)  
COUNTY OF: NORFOLK STATE: VA

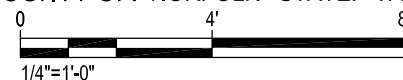

SHT 14 OF 16

11/20/21

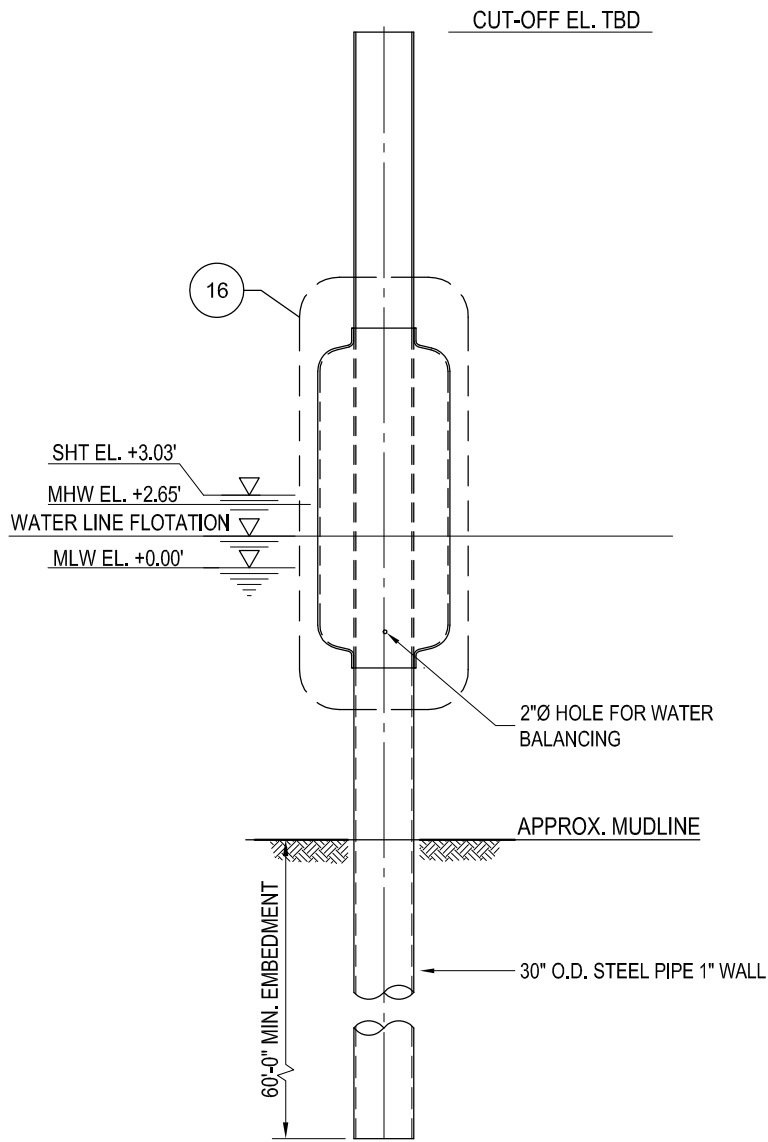

**15** **MONOPILE ELEVATION**  
 1/8"=1'-0"

NOTE:  
 1. REFERENCE DATUM IS TO MEAN LOW WATER (MLW).

DATUM: NAVD88

ADJACENT OWNERS:  
 1. REFER TO SECTION 14 OF THE JOINT PERMIT APPLICATION FOR THE LIST OF ADJACENT PROPERTY OWNERS.

**NAO PIER - SMALL CRAFT HARBOR**

APPLICANT: Lesley Dobbins-Noble  
 United States Army Corps Of Engineers  
 Norfolk District 803 Front St.  
 Norfolk, VA 23510  
 AGENT: M.G. McLaren Engineering  
 and Land Surveying, P.C.  
 530 Chestnut Ridge Rd.  
 Woodcliff Lake, NJ 07677

**MONOPILE & FLOATING DONUT FENDER**

IN: ELIZABETH RIVER  
 AT: NORFOLK (NORFOLK HARBOR)  
 COUNTY OF: NORFOLK STATE: VA



SHT 15 OF 16

11/20/21

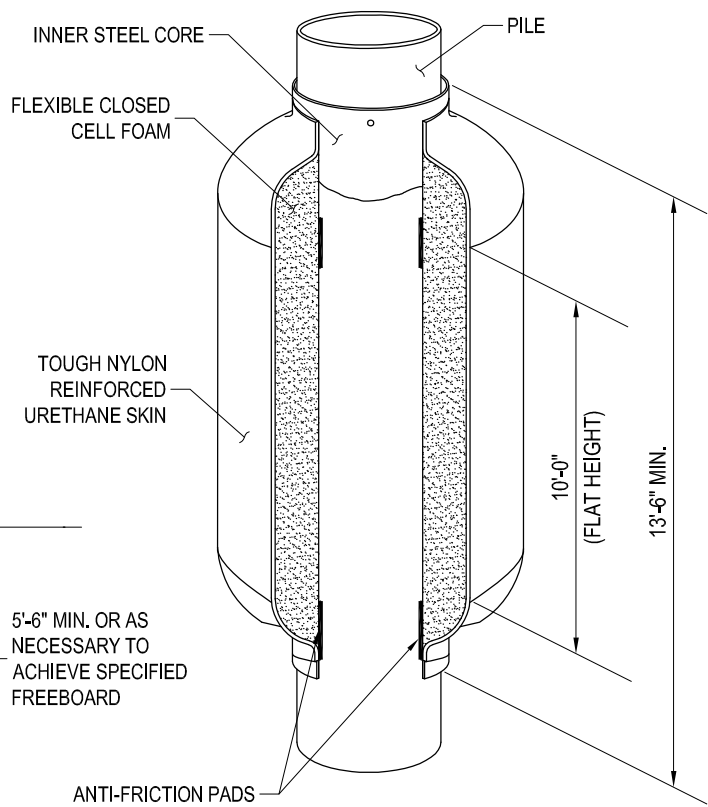
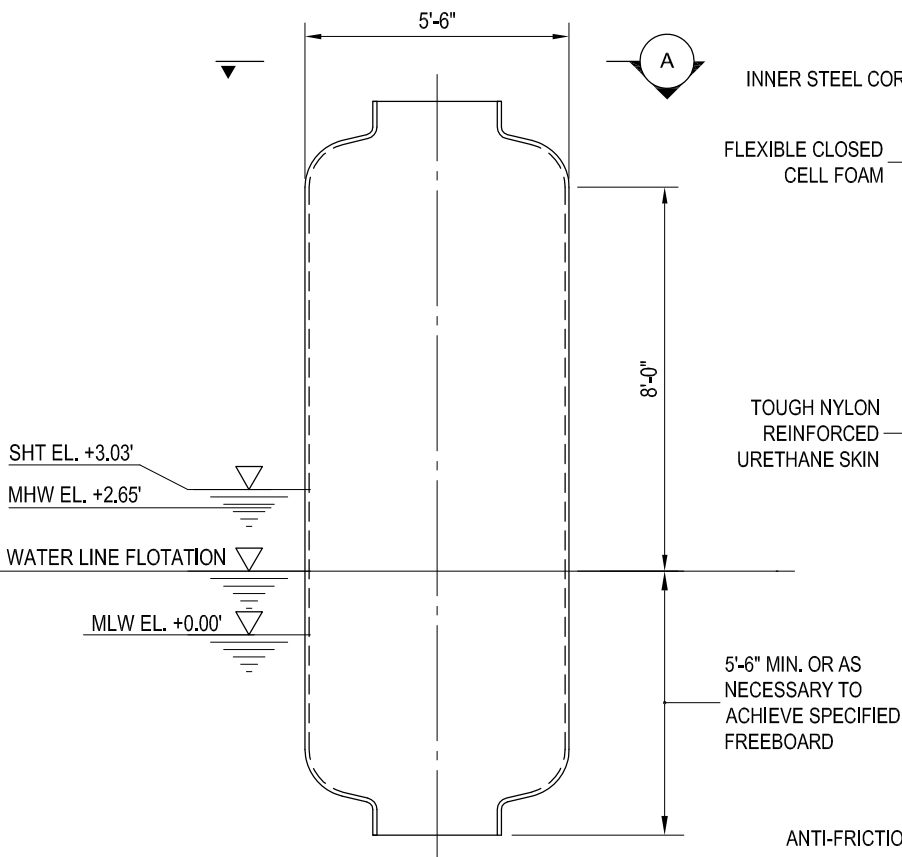
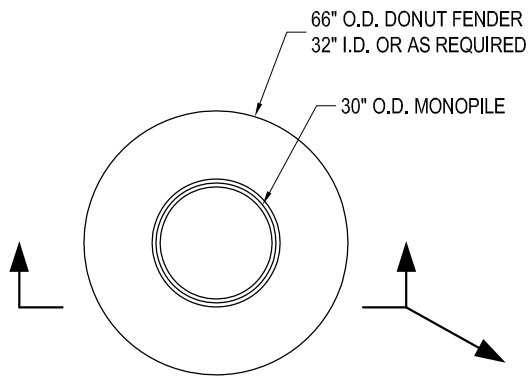

**16 DONUT FENDER**  
1/4"=1'-0"

**A SECTION**  
N.T.S.

NOTE:  
1. REFERENCE DATUM IS TO MEAN LOW WATER (MLW).

DATUM: NAVD88

**NAO PIER - SMALL CRAFT HARBOR**

ADJACENT OWNERS:  
1. REFER TO SECTION 14 OF THE JOINT PERMIT APPLICATION FOR THE LIST OF ADJACENT PROPERTY OWNERS.

APPLICANT: Lesley Dobbins-Noble  
United States Army Corps Of Engineers  
Norfolk District 803 Front St.  
Norfolk, VA 23510

AGENT: M.G. McLaren Engineering  
and Land Surveying, P.C.  
530 Chestnut Ridge Rd.  
Woodcliff Lake, NJ 07677

**FLOATING DONUT FENDER SECTIONS**

IN: ELIZABETH RIVER  
AT: NORFOLK (NORFOLK HARBOR)  
COUNTY OF: NORFOLK STATE: VA

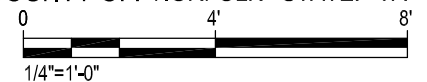

SHT 16 OF 16

11/20/21

## Reinheimer, Shannon J CIV USARMY CENAO (USA)

---

**From:** David OBrien - NOAA Federal <david.l.obrien@noaa.gov>  
**Sent:** Thursday, March 3, 2022 4:44 PM  
**To:** Reinheimer, Shannon J CIV USARMY CENAO (USA)  
**Cc:** Brian D Hopper - NOAA Federal; Meagan Riley - NOAA Federal  
**Subject:** [Non-DoD Source] NOAA EFH response for Fort Norfolk (NAO) Pier Rehabilitation and Expansion Project

Hello Shannon,

I have reviewed the coordination materials you sent regarding the proposed rehabilitation and improvements to the US Army Corps of Engineers, Norfolk District pier located along Elizabeth River in the City of Norfolk, Virginia. As you know, the Elizabeth River is designated as essential fish habitat (EFH) for 8 federally managed species and is also designated an anadromous fish use area by the Virginia Department of Wildlife Resources (DWR).

The project includes the construction of three new floating piers adjacent to the existing concrete pile supported decked pier to provide berths for the Corps' three 65 ft. survey vessels. The new concrete floating piers will be anchored using twenty-two 30-inch diam. hollow steel pipe piles. A 310-ft. timber wave screen will be constructed 98-ft. channelward of the existing pier to provide protection from wave energy and severe storm events. Twenty-one 30-inch hollow steel piles will be installed as the framework for the timber wavescreen. Other project elements include an additional 18-inch and 30-inch hollow steel piles along with 12-inch timber piles. Of the project's 64 total piles to be installed via vibratory hammer, eight 30-inch hollow steel piles will be advanced with a vibratory hammer but driven the last 10-ft. to design depth to verify lateral axial loading capacity.

Installation of the hollow steel piles during construction of the floating piers and wave screens will result in acoustic impacts to NOAA trust resources and other aquatic organisms. Based on our Protected Resources Division's [Acoustic Tool](#), the area ensounded by the vibratory installation of 30-inch hollow steel piles to sound levels resulting in behavioral disturbance to fish (150 dB re 1 uPA RMS) will extend approximately 70-m from the sound source. The eight 30-inch piles to be started using a vibratory hammer and then driven the last 10-ft. to design depth with an impact hammer will ensound an area extending 90-m from the sound source. The use of a "soft-start" is proposed to help scare fish away from the work area before driving piles at full hammer energy.

We estimate the most channelward 30-inch hollow steel piles used to construct the wave screen will be located approximately 510-meters (588-yds.) from the opposite shoreline. Therefore, while vibratory and impact pile driving will adversely affect EFH resulting in acoustic impacts up to 90-m from the sound source, a sufficient zone of passage will exist for resident, transient and migratory species to pass through the work area. The proposed use of turbidity curtains during construction will help limit resuspended sediment from entering the adjacent water column. We anticipate any elevated levels of total suspended solids during construction to be minor and temporary.

Based on the available zone of fish passage and relatively minimal and temporary impacts to water quality during construction, NOAA Fisheries Service concurs with your determination that the proposed pier rehabilitation and expansion project will not substantially adversely affect essential fish habitat (EFH) and is of the opinion given the scope of proposed work, a time of year restriction to help protect the migration and spawning of anadromous fish is not warranted.

Please note this EFH determination does not address threatened and endangered species under the purview of NOAA Fisheries Service. We understand you have submitted a GARFO ESA Section 7: NLAA Program Verification Form to NOAA's Protected Resources Division (PRD). If you have any questions regarding the

Section 7 consultation process please contact Mr. Brian Hopper, NOAA Protected Resources Division ([brian.d.hopper@noaa.gov](mailto:brian.d.hopper@noaa.gov), 240-628-5420) for assistance.

Thank you for the opportunity to comment on this project. Please feel free to contact me if you have any questions.

Regards,  
Dave

David L. O'Brien  
Fisheries Biologist  
NOAA Fisheries Service  
P.O. Box 1346  
1370 Greate Rd.  
Gloucester Point, VA 23062  
804-684-7828  
[david.l.obrien@noaa.gov](mailto:david.l.obrien@noaa.gov)

NOTICE: I am teleworking until further notice. I will be checking my phone messages regularly and will return calls as quickly as possible. Please stay well.

On Thu, Mar 3, 2022 at 11:35 AM Reinheimer, Shannon J CIV USARMY CENAO (USA) <[Shannon.J.Reinheimer@usace.army.mil](mailto:Shannon.J.Reinheimer@usace.army.mil)> wrote:

Dave,

No worries. It has been a very busy year. Please see below and attached for the EFH transmittal and EFH Consultation package for the project. I apologize if I made it confusing by copying you on the Section 7 NLAA form. I appreciate your review and recommendations on the project.

Thanks!

Shannon J. Reinheimer

Environmental Scientist

Technical Support Section, Operations Branch

U.S. Army Corps of Engineers

Norfolk District, Operations Branch

757-201-7074

---

**From:** Reinheimer, Shannon J CIV USARMY CENAO (USA)

**Sent:** Thursday, January 6, 2022 1:46 PM

**To:** [david.l.obrien@noaa.gov](mailto:david.l.obrien@noaa.gov)

**Cc:** Wright, Javier Ann F CIV USARMY CENAO (USA) <[JavierAnn.F.Wright@usace.army.mil](mailto:JavierAnn.F.Wright@usace.army.mil)>; Pruhs, Robert S CIV USARMY CENAO (USA) <[Robert.S.Pruhs@usace.army.mil](mailto:Robert.S.Pruhs@usace.army.mil)>

**Subject:** EFH Package for Fort Norfolk (NAO) Pier Rehabilitation and Expansion

Good Afternoon,

Please find attached the transmittal letter and Essential Fish Habitat package for the NAO Pier Rehabilitation and Improvements Project, located in Norfolk, Virginia. This project includes improvements to the existing NAO pier to allow for the safe mooring of three 65 feet vessels and to protect the mooring location from wave action and severe storm events. We conducted a Pre-Application meeting for this project on 18 October 2021. Please let me know if you have any additional questions or require further information on this submittal. Thank you for your time and attention to this project.

Shannon J. Reinheimer

Environmental Scientist

Technical Support Section, Operations Branch

U.S. Army Corps of Engineers

Norfolk District, Operations Branch

757-201-7074